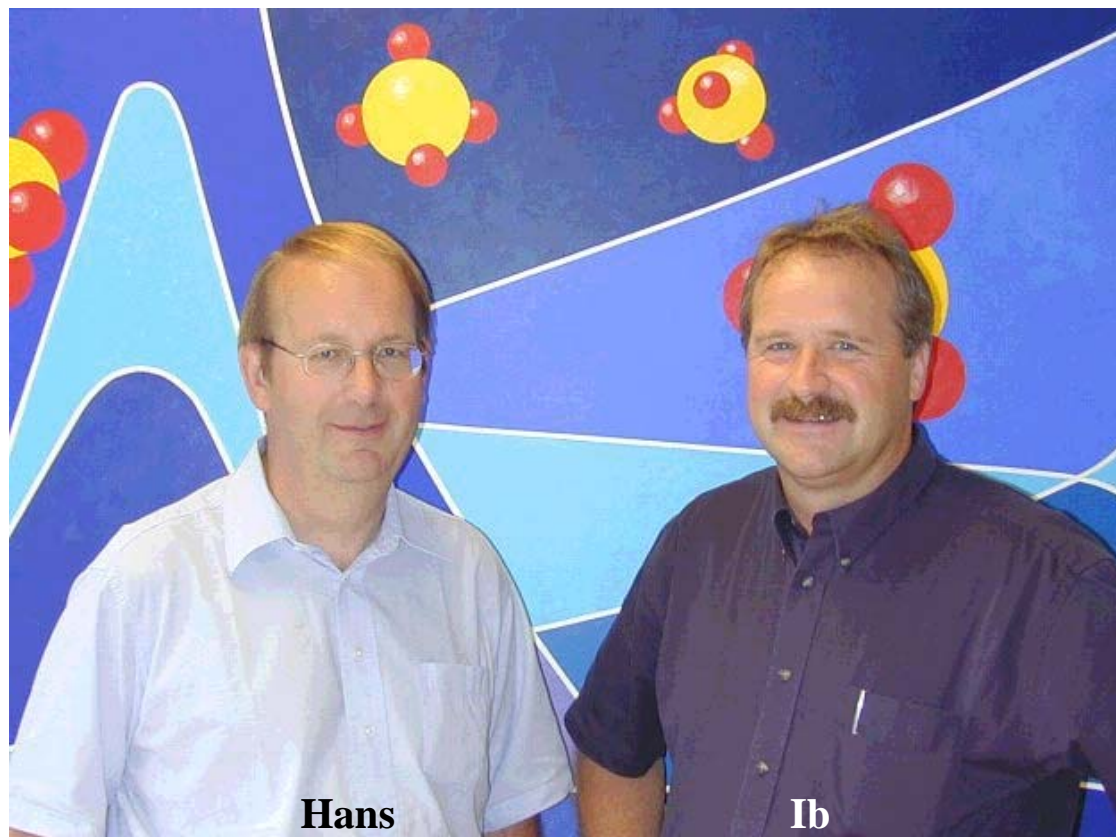


Hi,

In this PDF file we have included some of the most important figures from our book, some even in colour.

Feel free to use them in presentations, as long as you refer to the source.

Copyright of the figures rests with Wiley-VCH, where you can request permission if you want to use figures in publications, theses, etc.



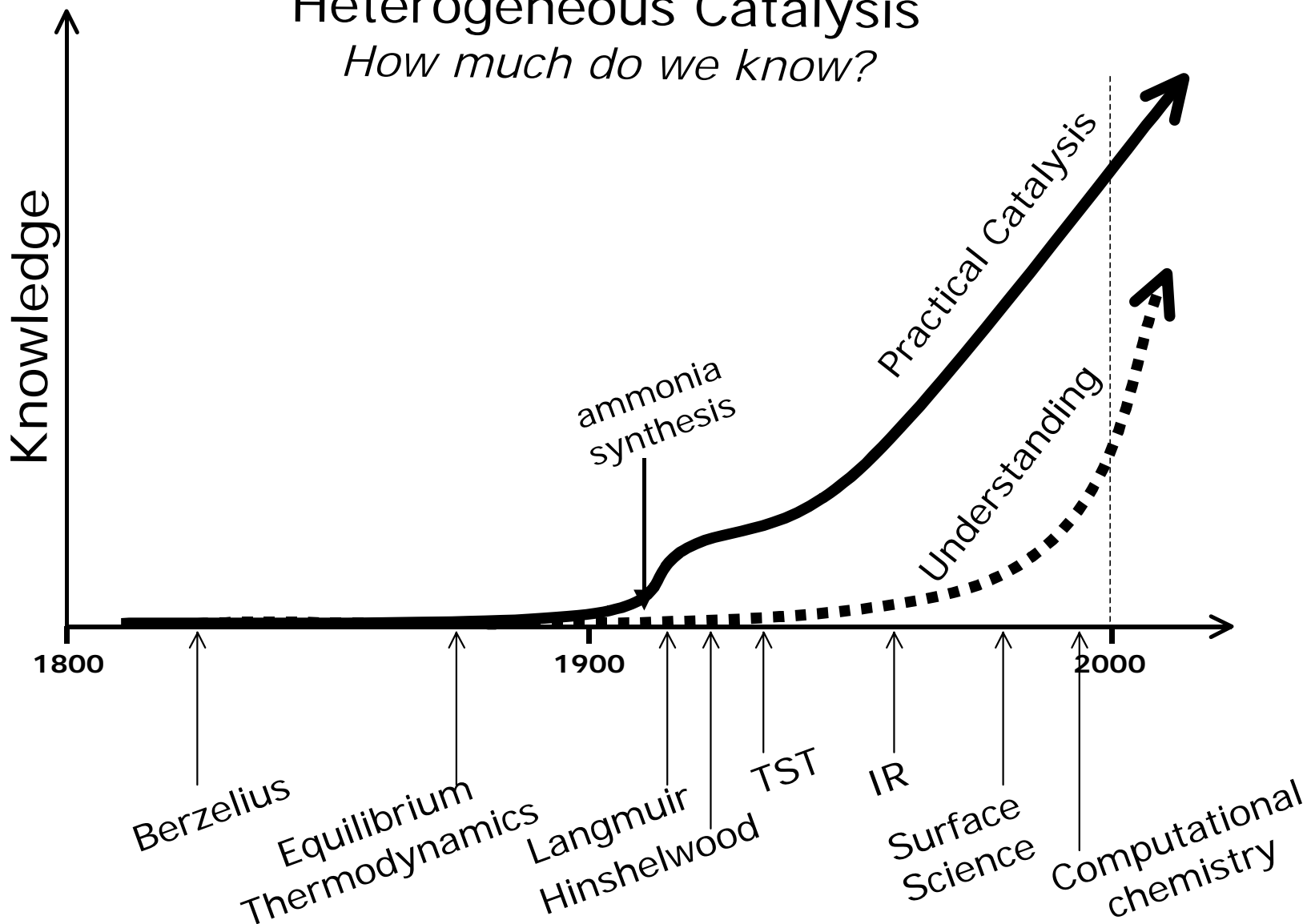
Ib Chorkendorff and Hans Niemantsverdriet



*Concepts of Modern Catalysis and Kinetics*. I. Chorkendorff, J.W. Niemantsverdriet  
Copyright © 2003 WILEY-VCH Verlag GmbH & Co. KGaA, Weinheim  
ISBN: 3-527-30574-2

# Heterogeneous Catalysis

*How much do we know?*



*Concepts of Modern Catalysis and Kinetics*. I. Chorkendorff, J.W. Niemantsverdriet  
Copyright © 2003 WILEY-VCH Verlag GmbH & Co. KGaA, Weinheim  
ISBN: 3-527-30574-2

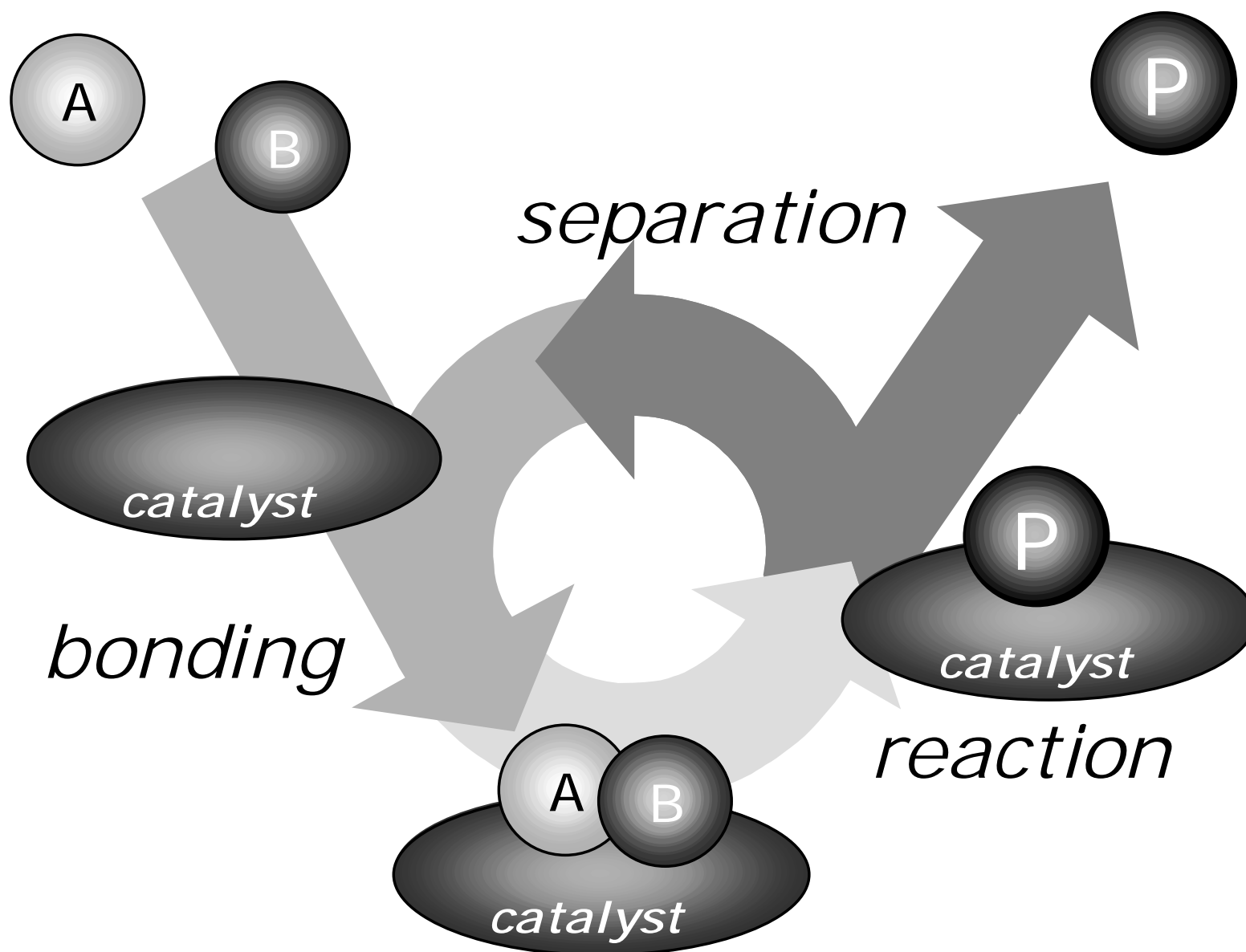


Figure 1.1

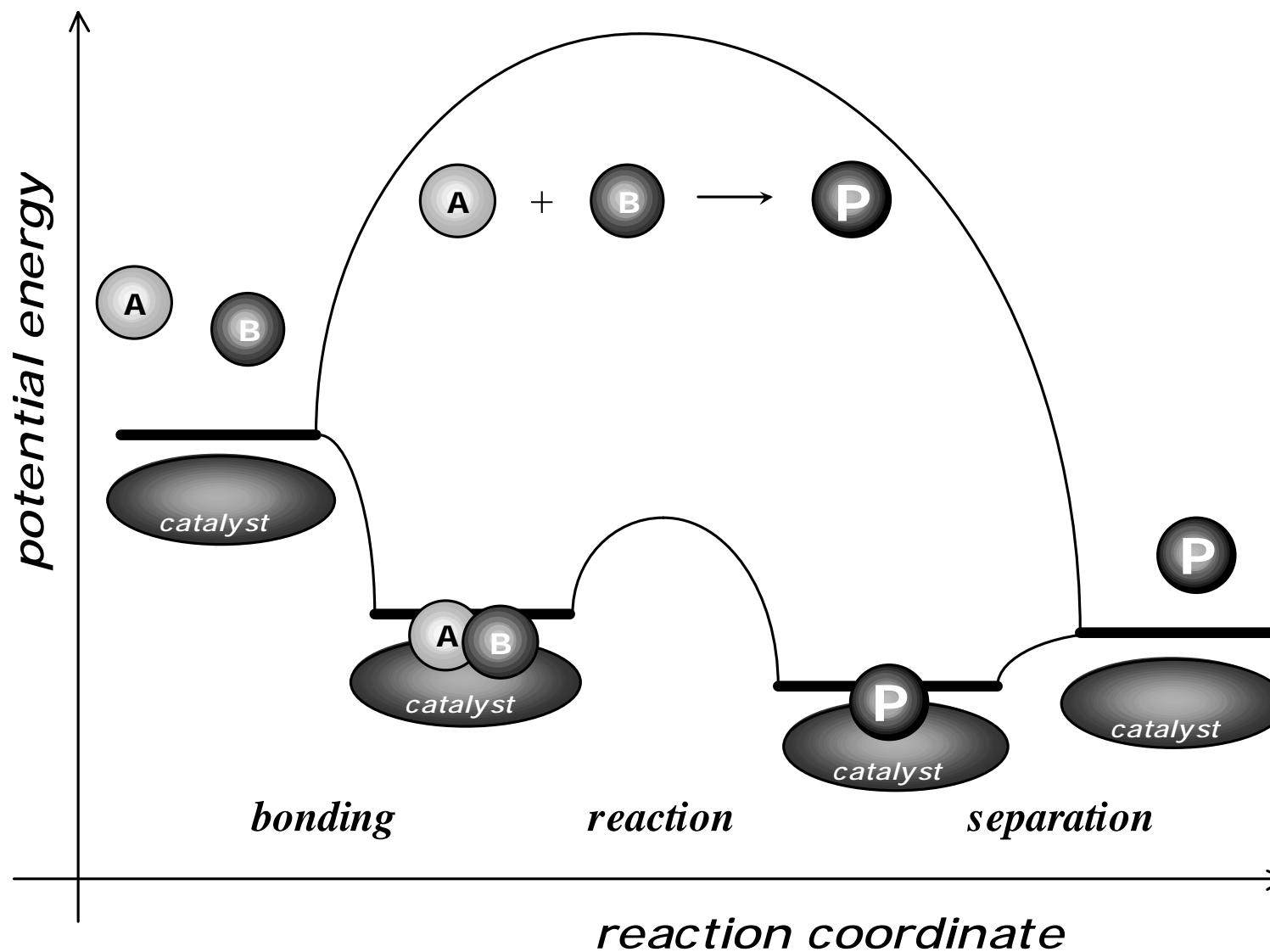


Figure 1.2

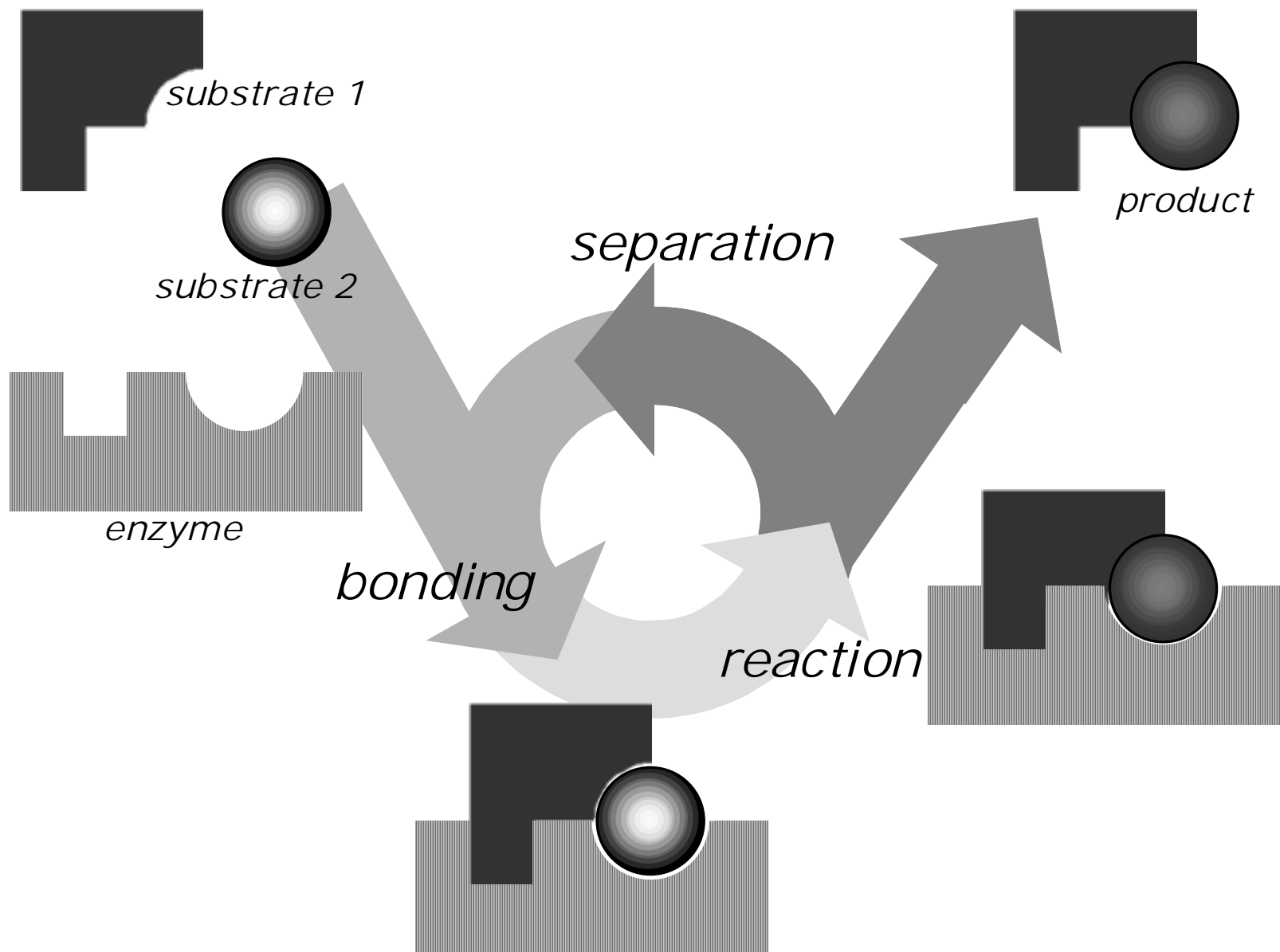


Figure 1.3

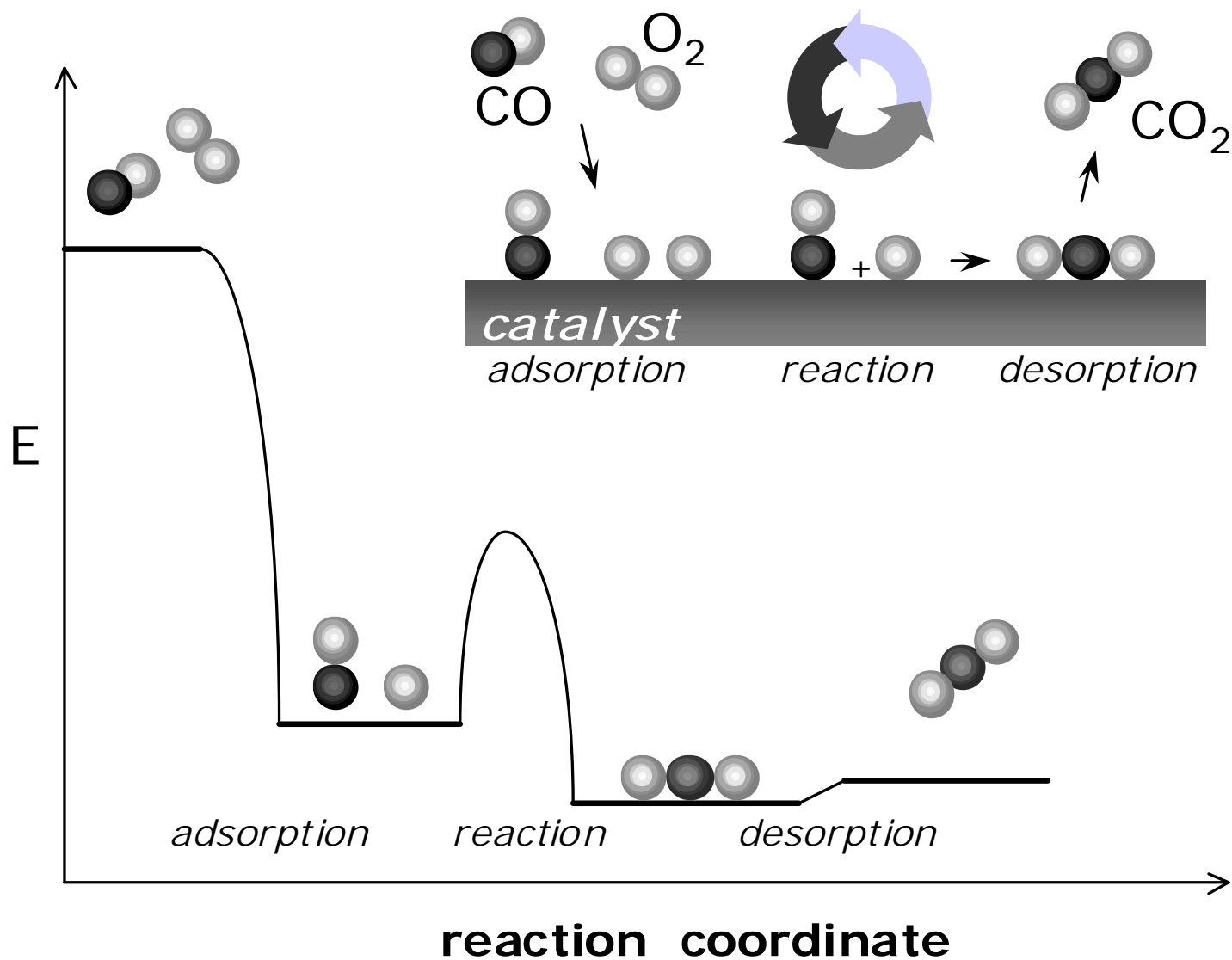


Figure 1.5

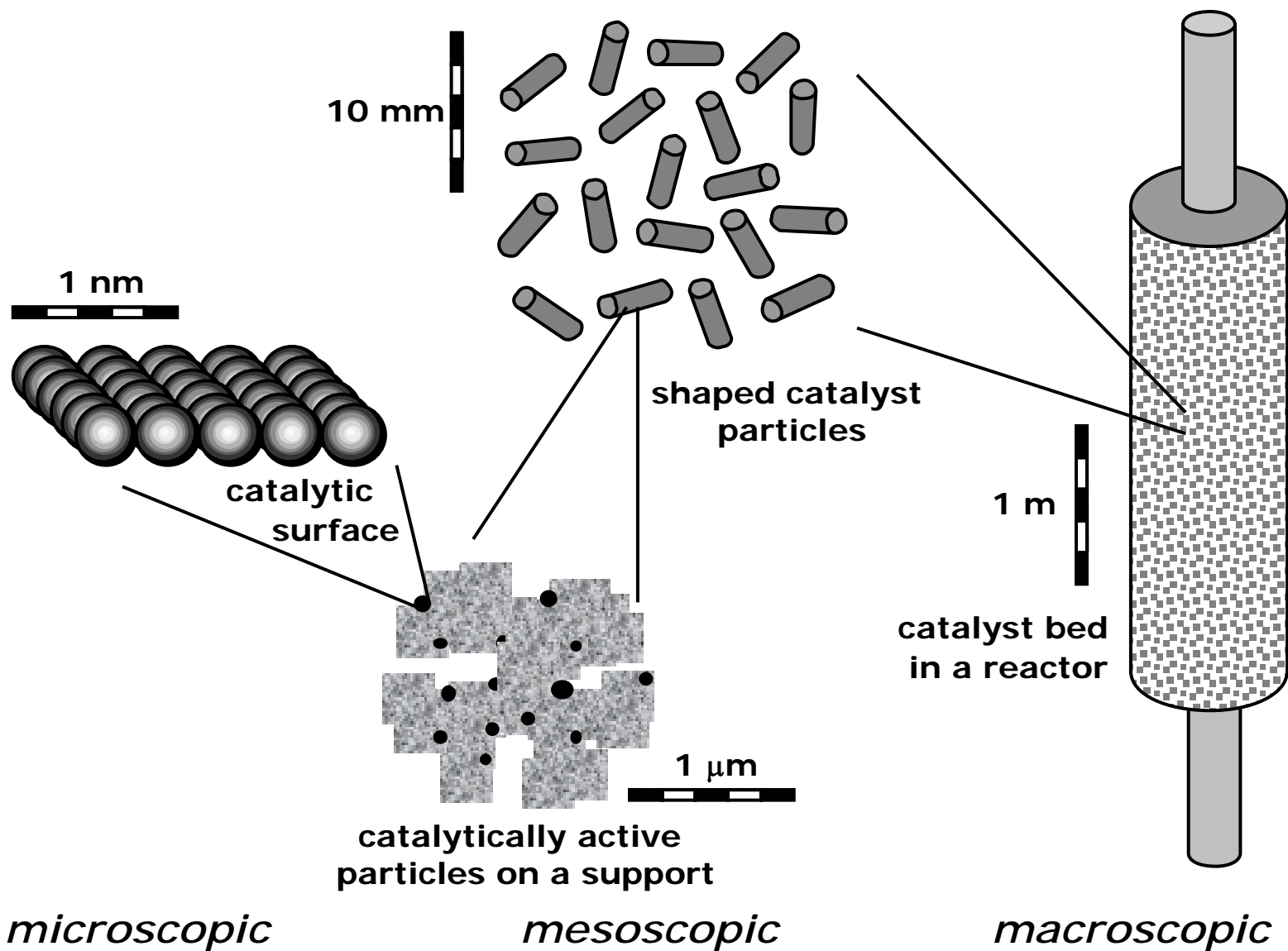
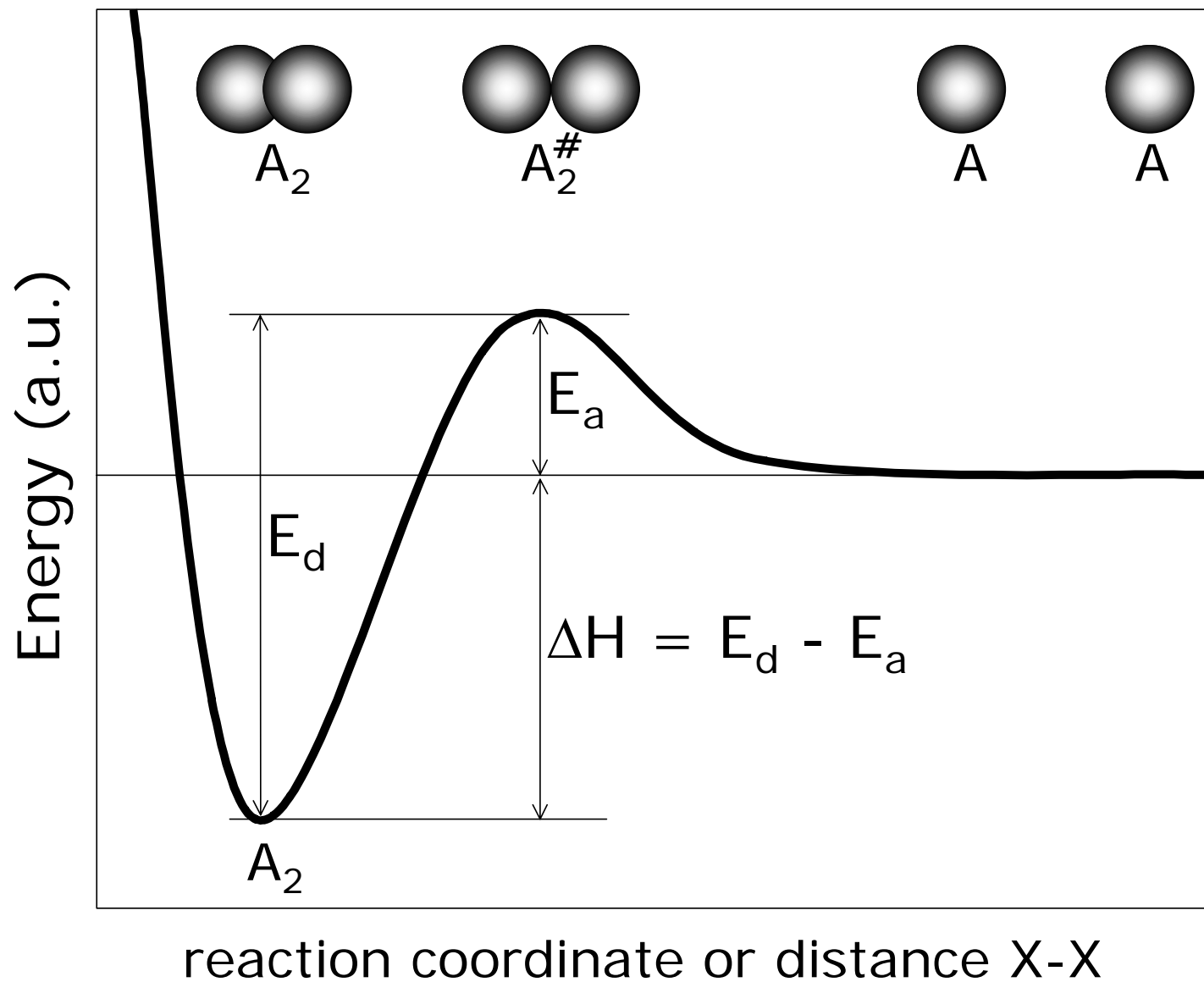
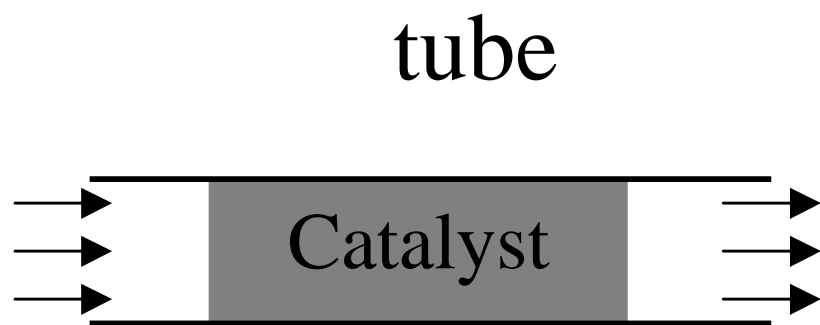


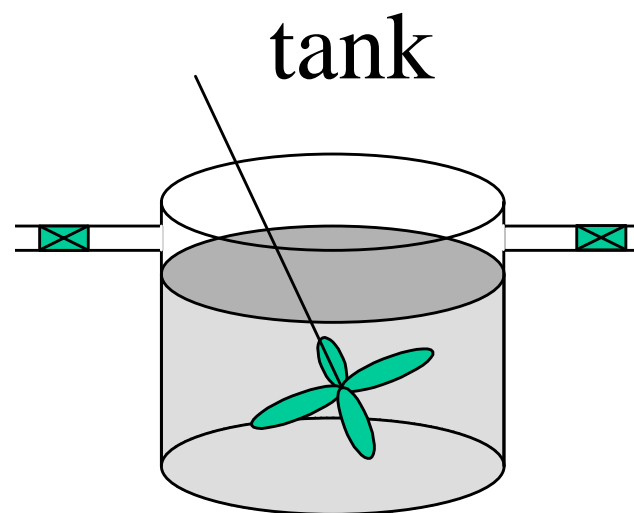
Figure 1.8







Flow reactor



Batch reactor



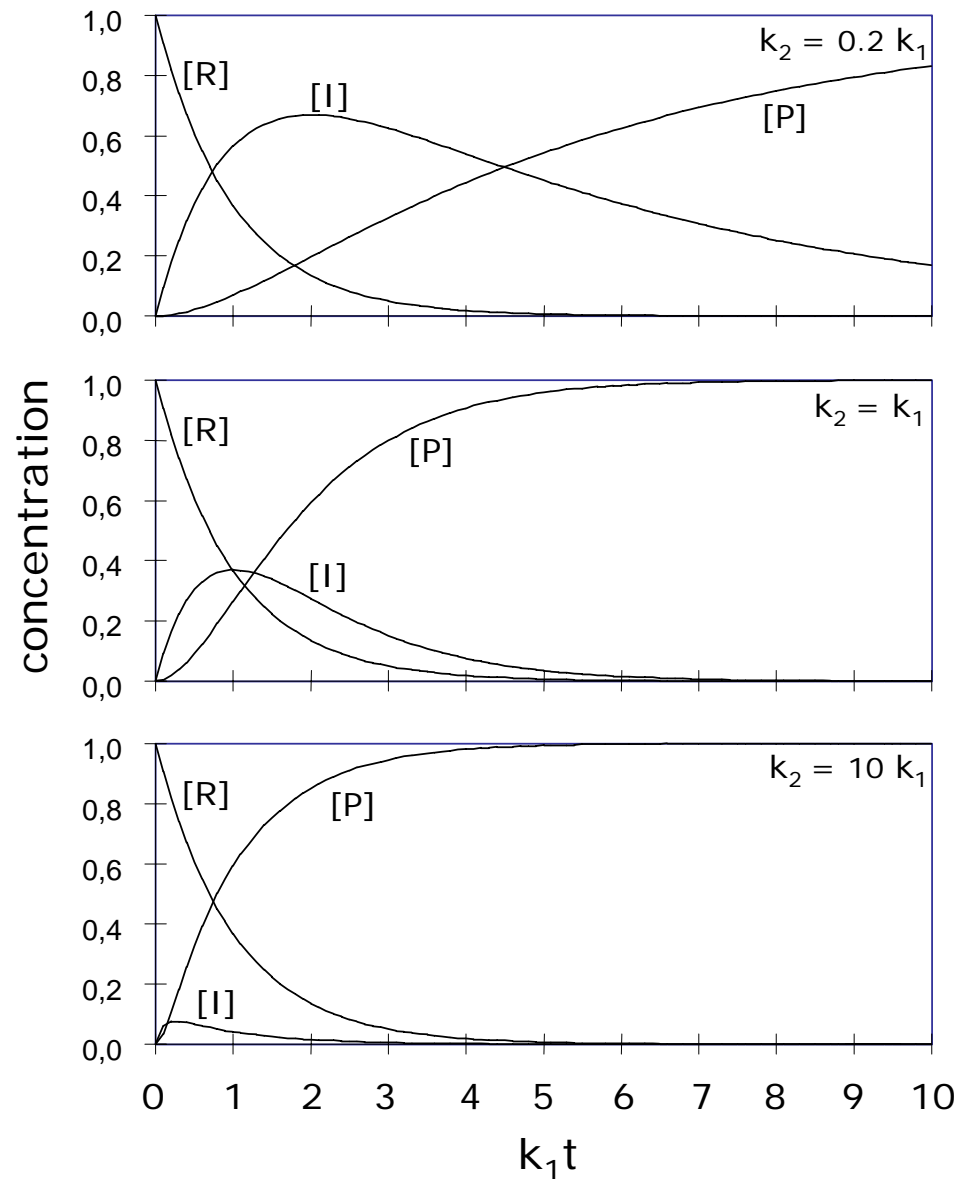
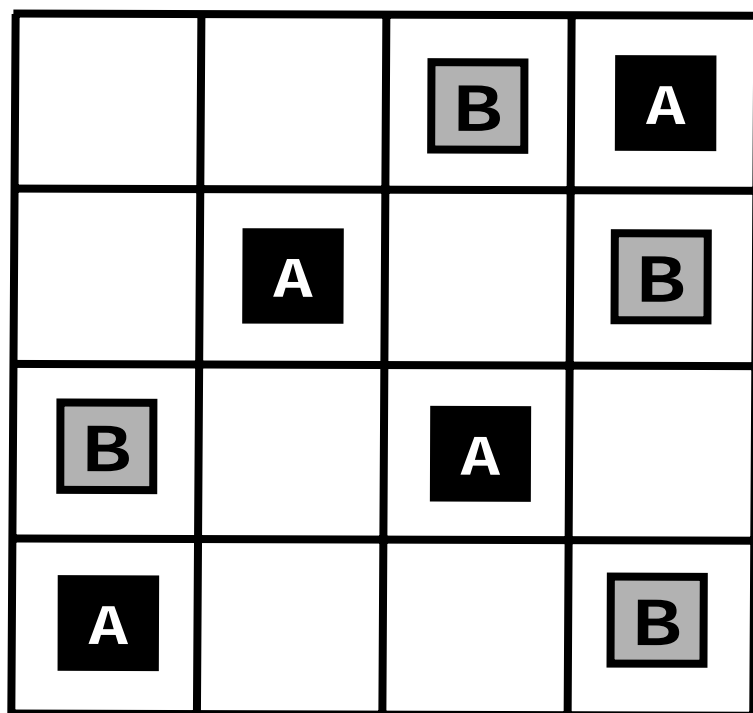
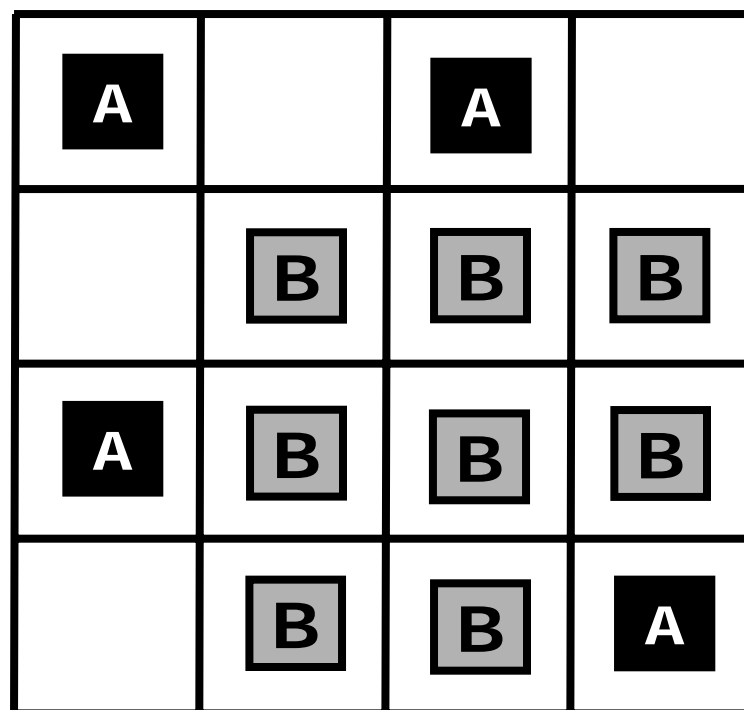


Figure 2.5



*random*

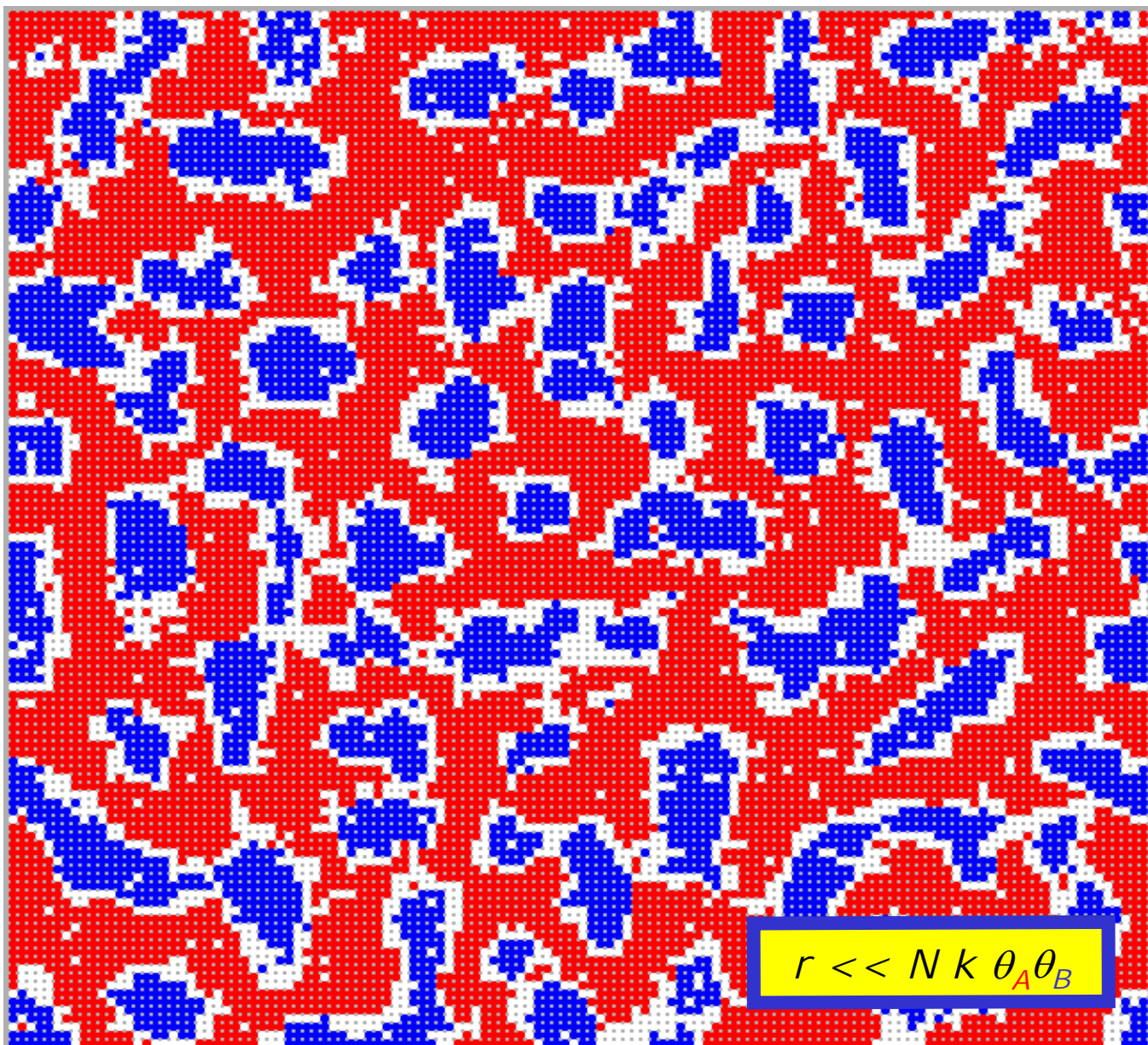
$$r = N k \theta_A \theta_B$$



*ordered*

$$r < N k \theta_A \theta_B$$





*Concepts of Modern Catalysis and Kinetics*. I. Chorkendorff, J.W. Niemantsverdriet  
Copyright © 2003 WILEY-VCH Verlag GmbH & Co. KGaA, Weinheim  
ISBN: 3-527-30574-2

Figure 2.9

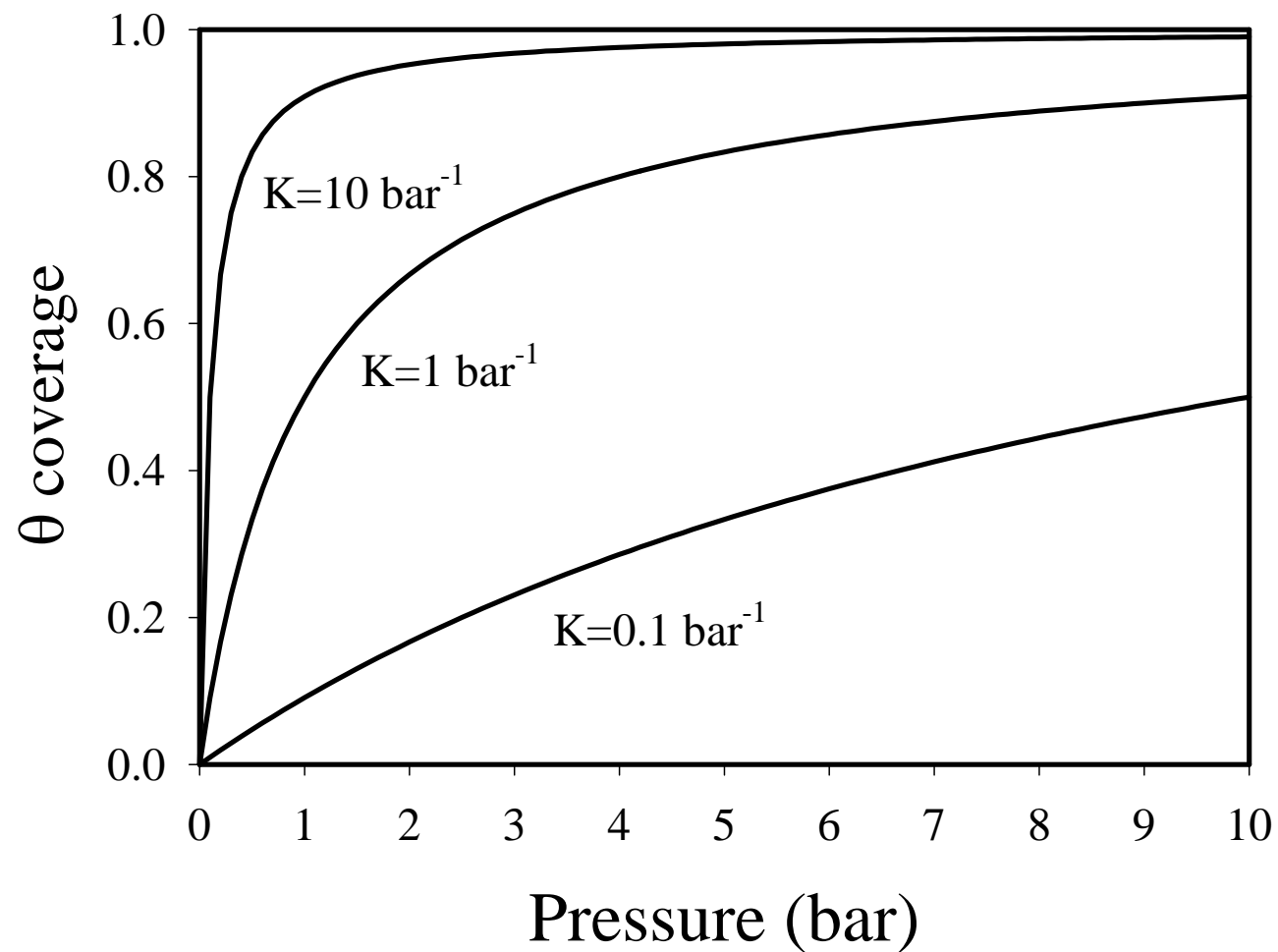


Figure 2.10

$K_a=1$  at 600 K,  $\Delta H_a=-125\text{kJ/mol}$   
 $K_b=1$  at 600 K,  $\Delta H_b=-125\text{kJ/mol}$ ,  $K_{ab}$  small,  
 $k=1$  at 540 K,  $E_a=+50\text{kJ/mol}$ , and  $P_b=5$

CO oxidation,  $K_{CO}=1$  at 650 K,  $\Delta H_{CO}=-135\text{kJ/mol}$   
 $K_{O_2}=1$  at 630 K,  $\Delta H_{O_2}=-250\text{kJ/mol}$ ,  $K_{CO_2}$  small,  
 $k=1$  at 540 K,  $E_a=50\text{kJ/mol}$ ,  $P_{O_2}=10 \cdot P_{CO}$ , and  $P_{CO}=1$

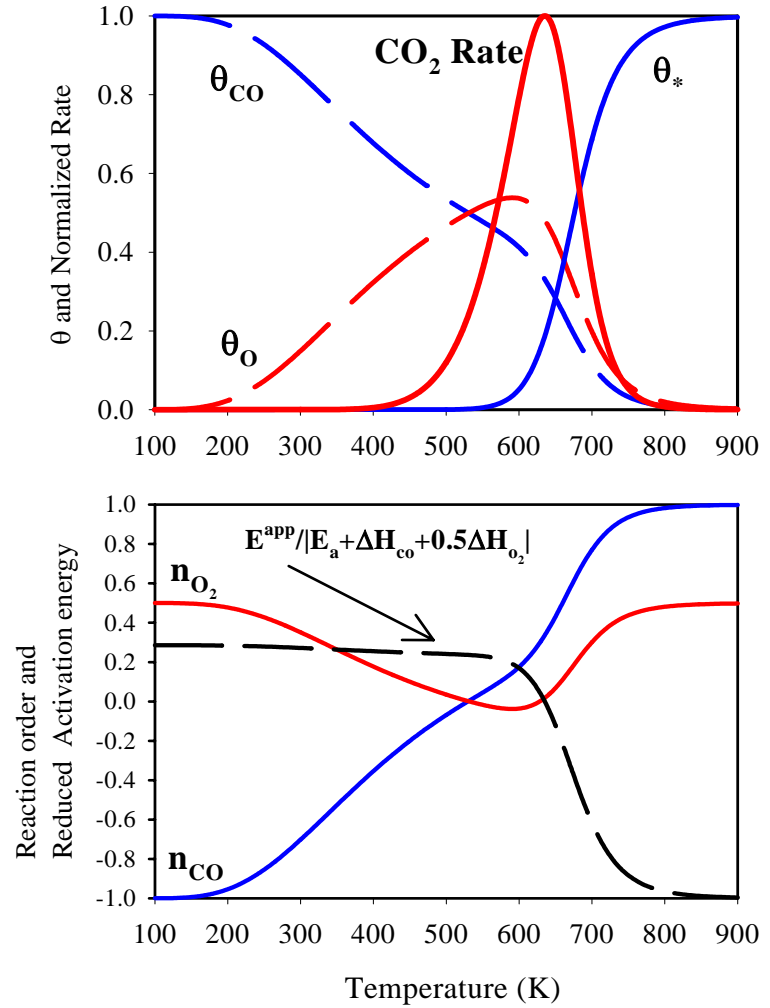
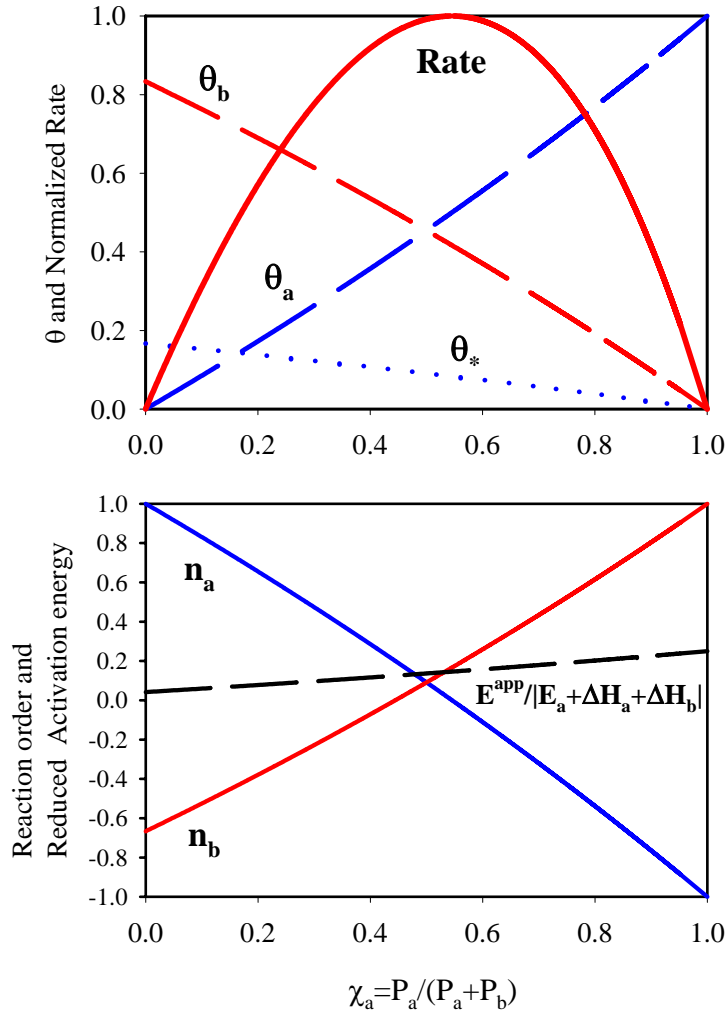
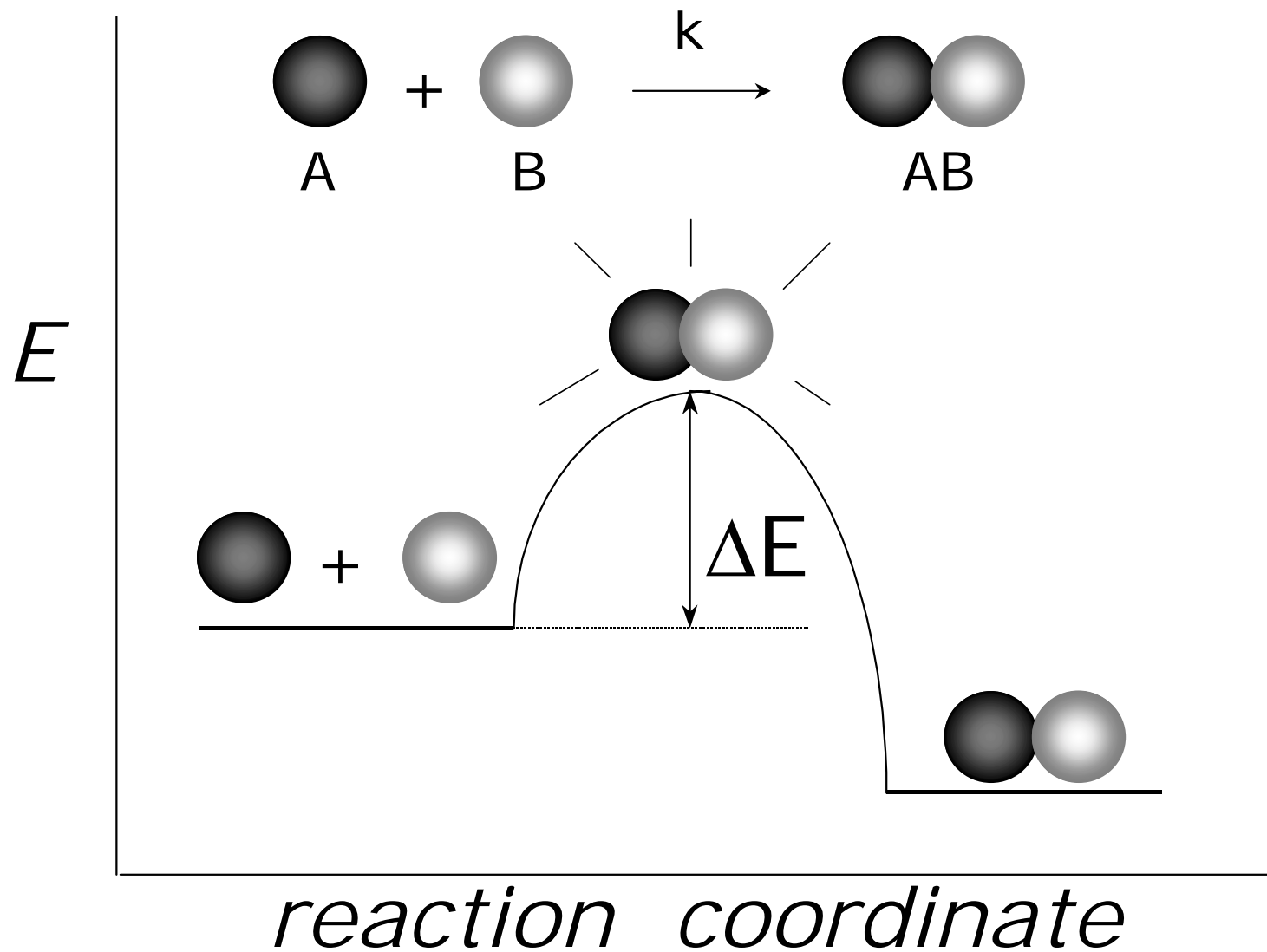


Figure 2.11 & 2.12



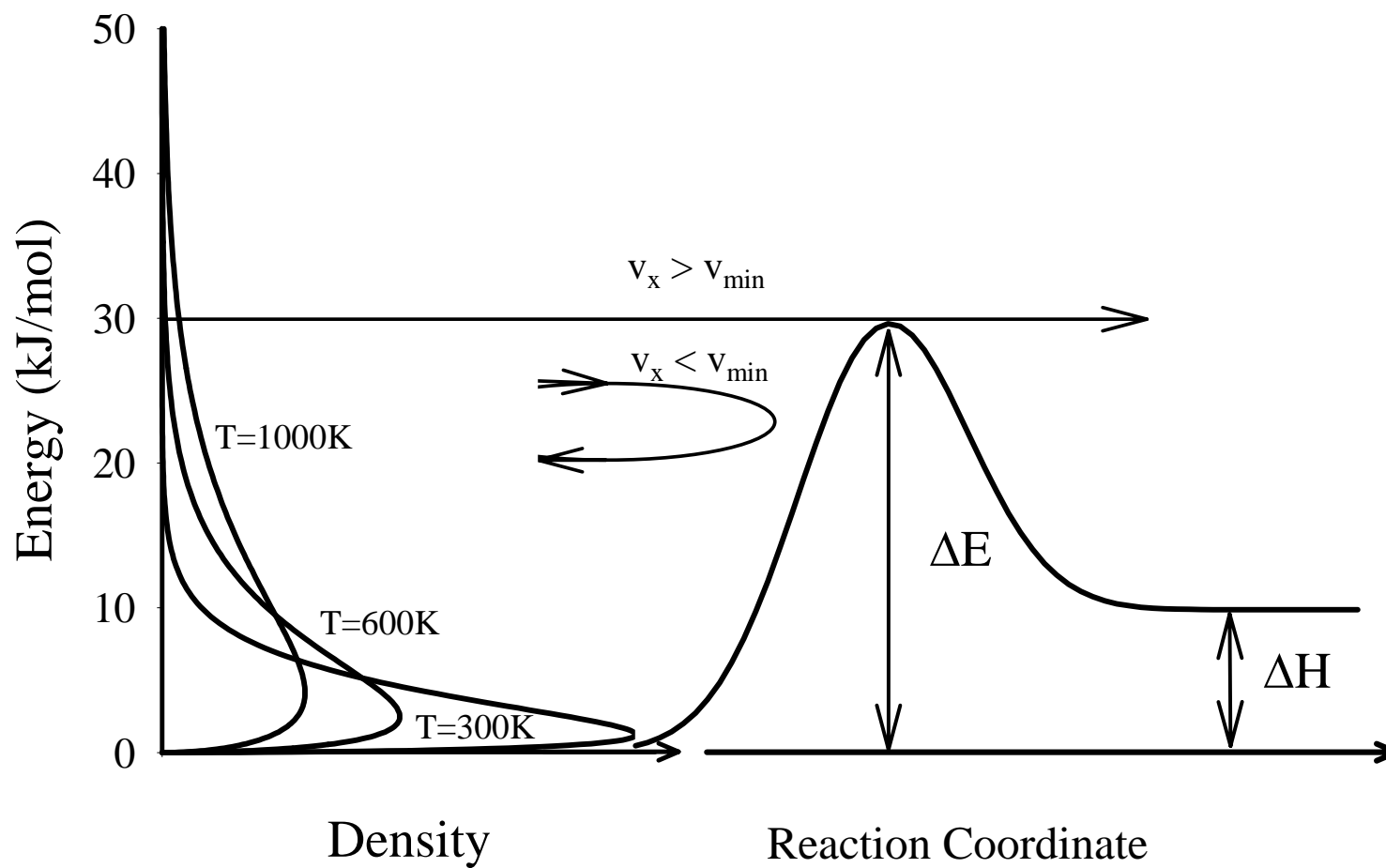
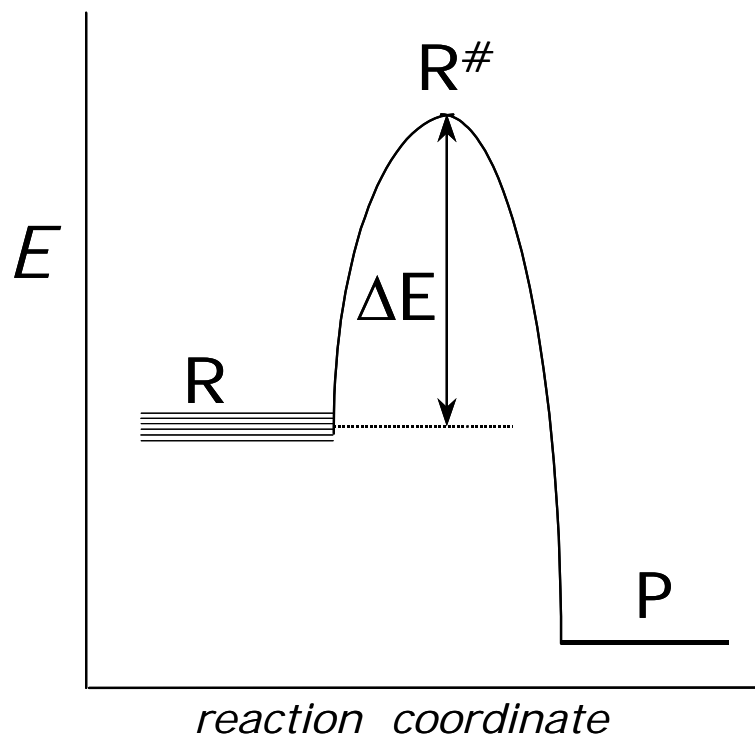


Figure 3.9



## Tight TST:

$$q^\# \ll q$$

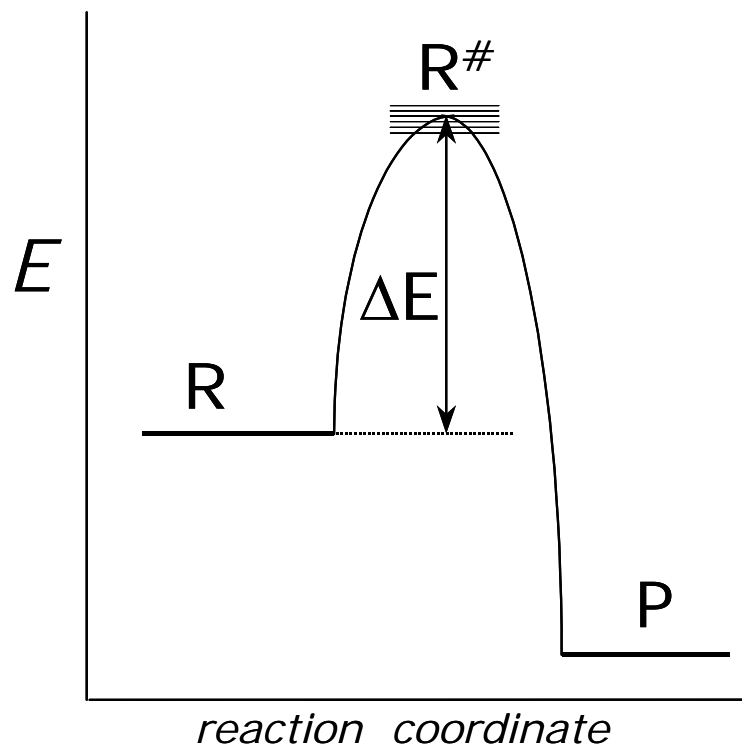


$$10^9 < \nu < 10^{13} \text{ s}^{-1}$$

$\Delta S^\#$  negative

## Loose TST:

$$q^\# \gg q$$



$$10^{13} < \nu < 10^{17} \text{ s}^{-1}$$

$\Delta S^\#$  positive



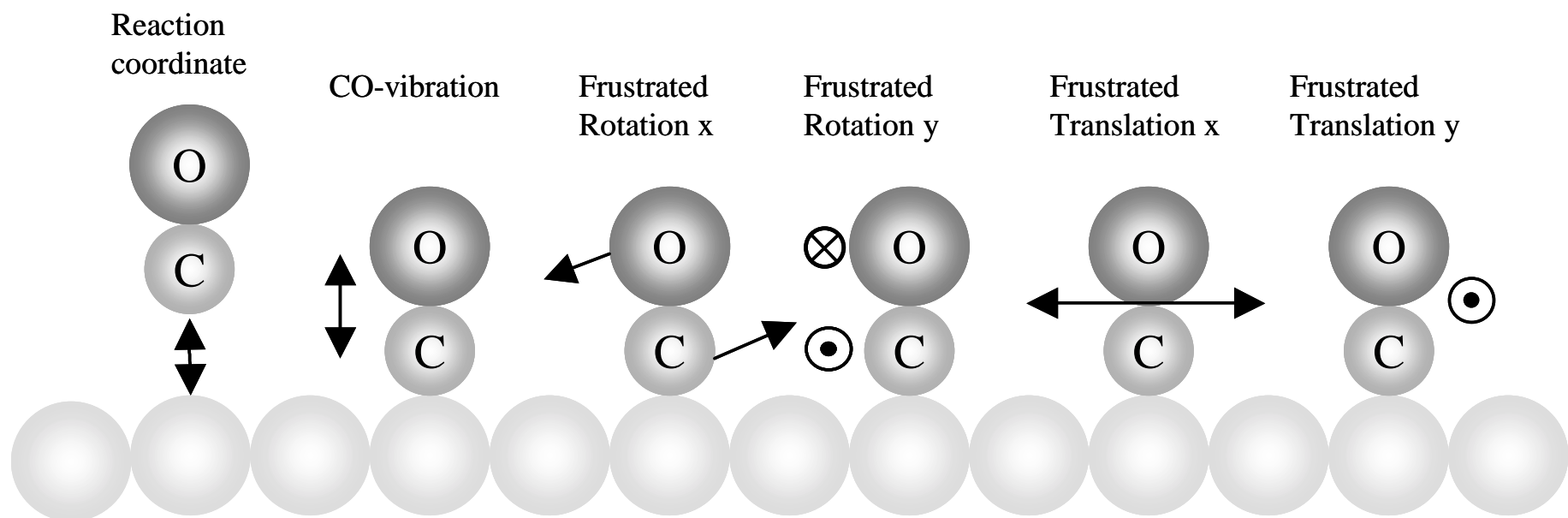


Figure 3.12

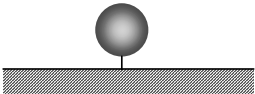
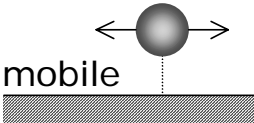
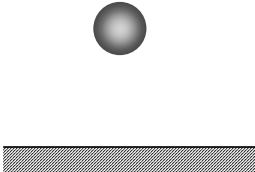
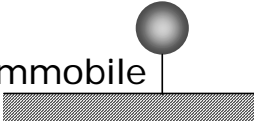
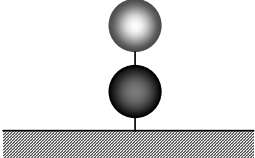
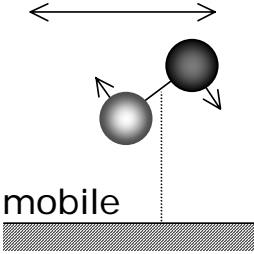
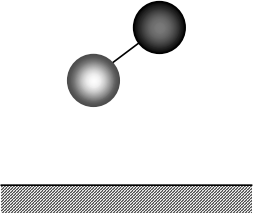
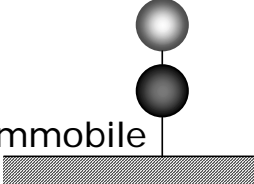
Adsorbed state	Transition state	Desorbed state	Preexponential factor
	 mobile		$\sim 10^{15} \text{ s}^{-1}$
	 immobile		$\sim 10^{13} \text{ s}^{-1}$
	 mobile		$\sim 10^{14-16} \text{ s}^{-1}$
	 immobile		$\sim 10^{13} \text{ s}^{-1}$



Figure 3.14

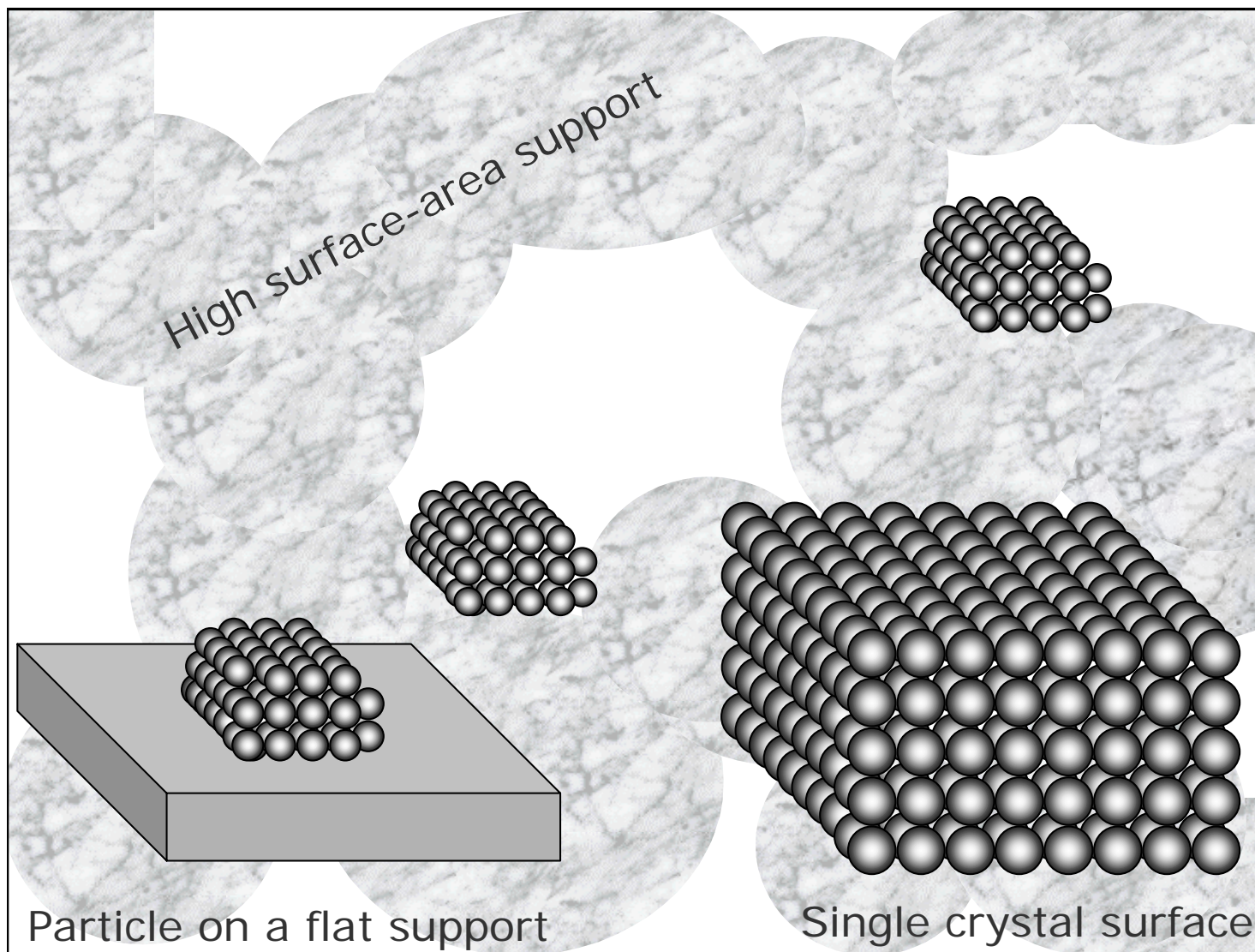
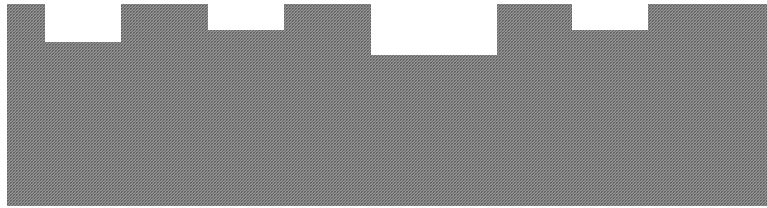


Figure 4.1



### Roughness

- features are wider than they are deep
- only external surface area



### Porosity

- features are deeper than they are wide
- internal and external surface area



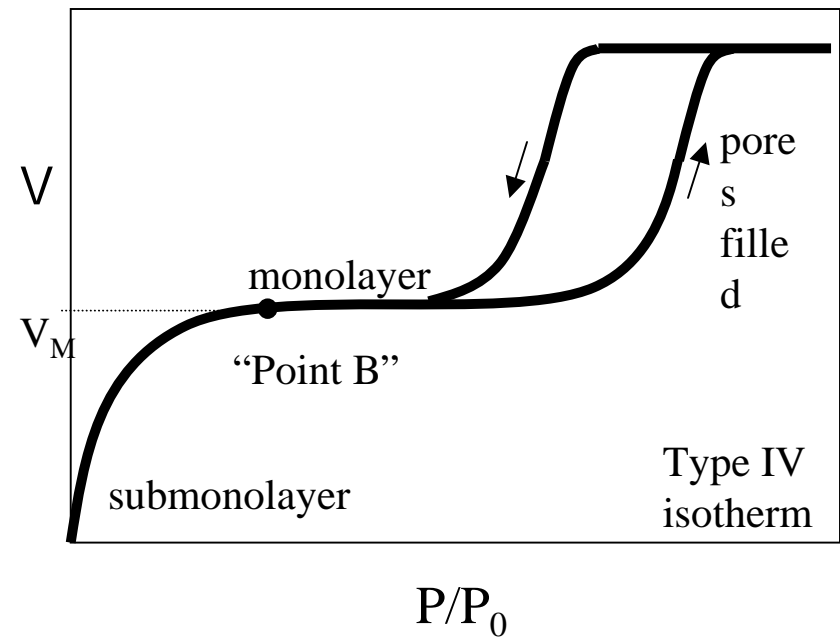
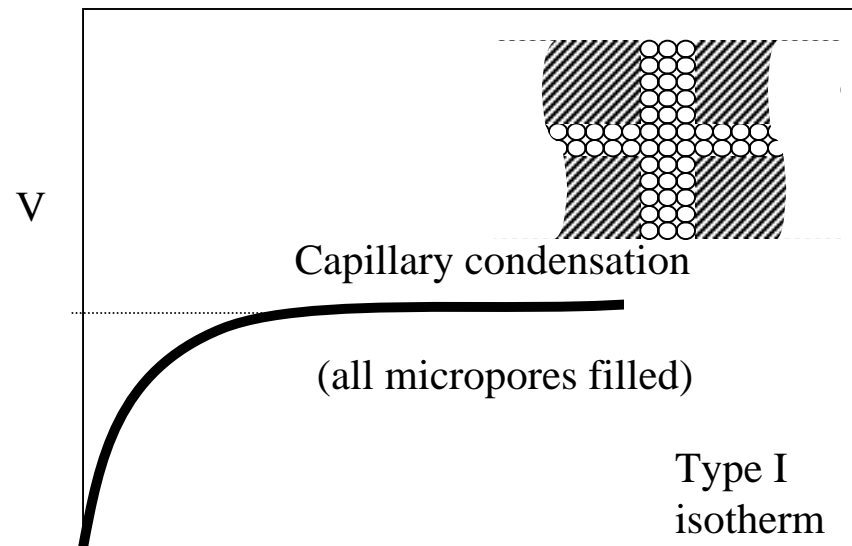
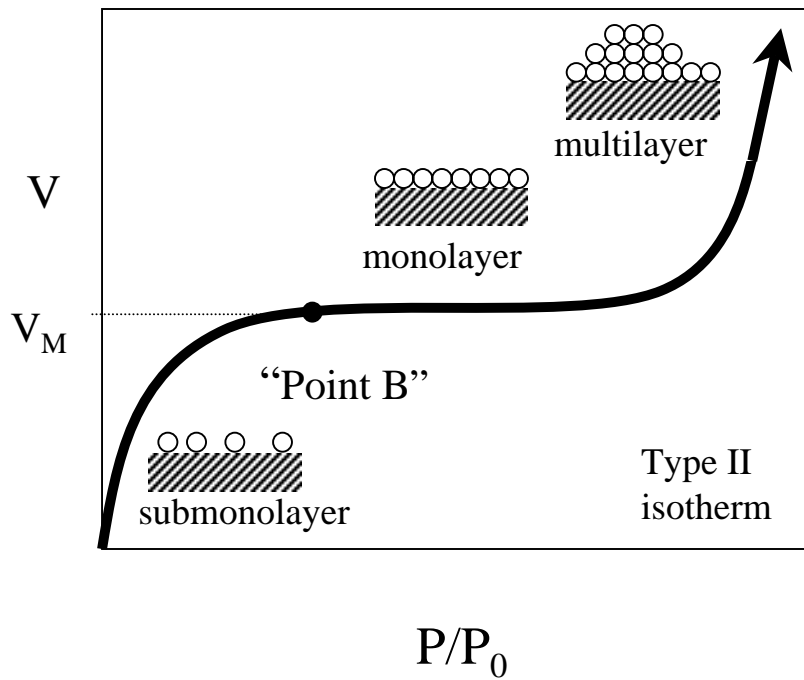


Figure 5.19-21



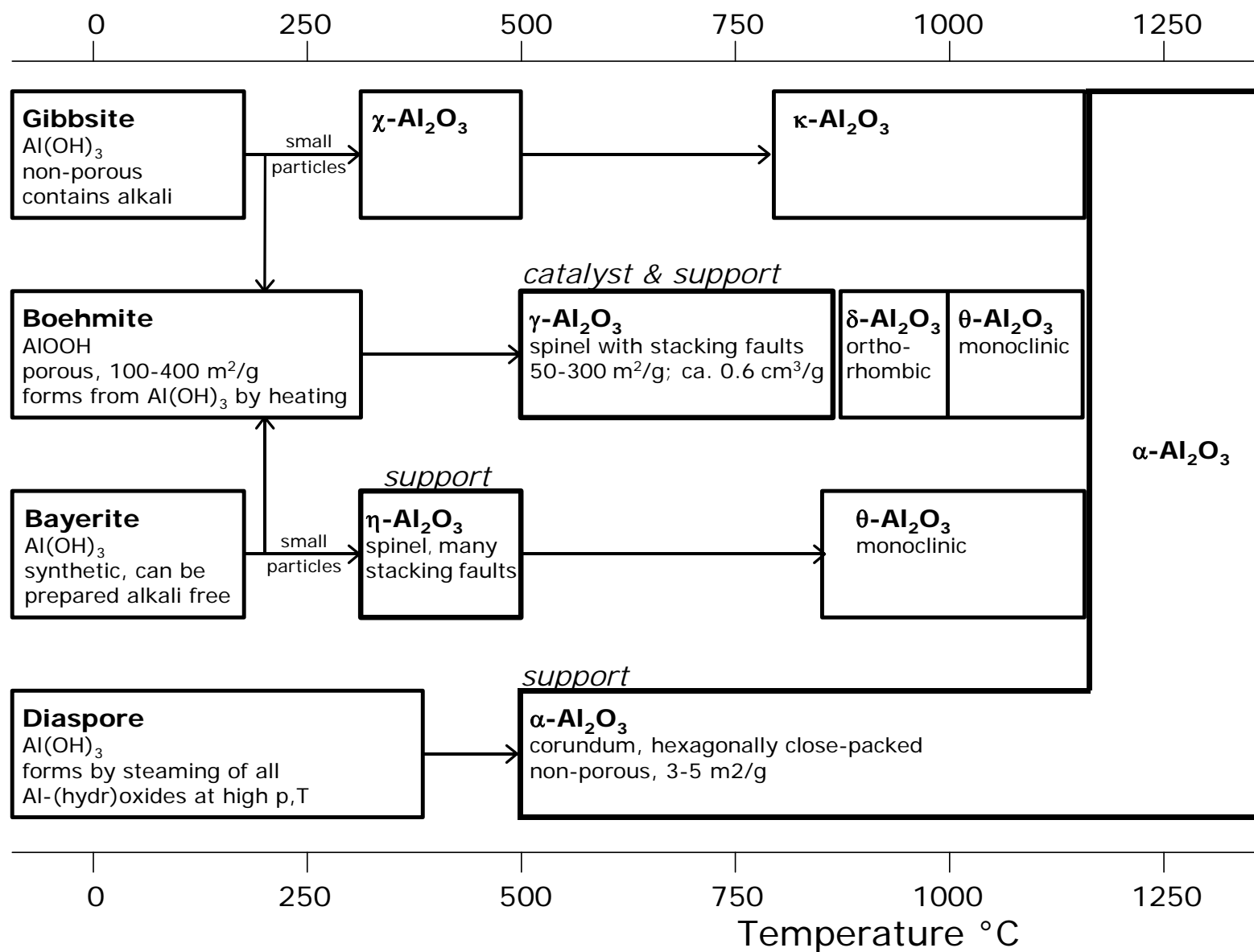
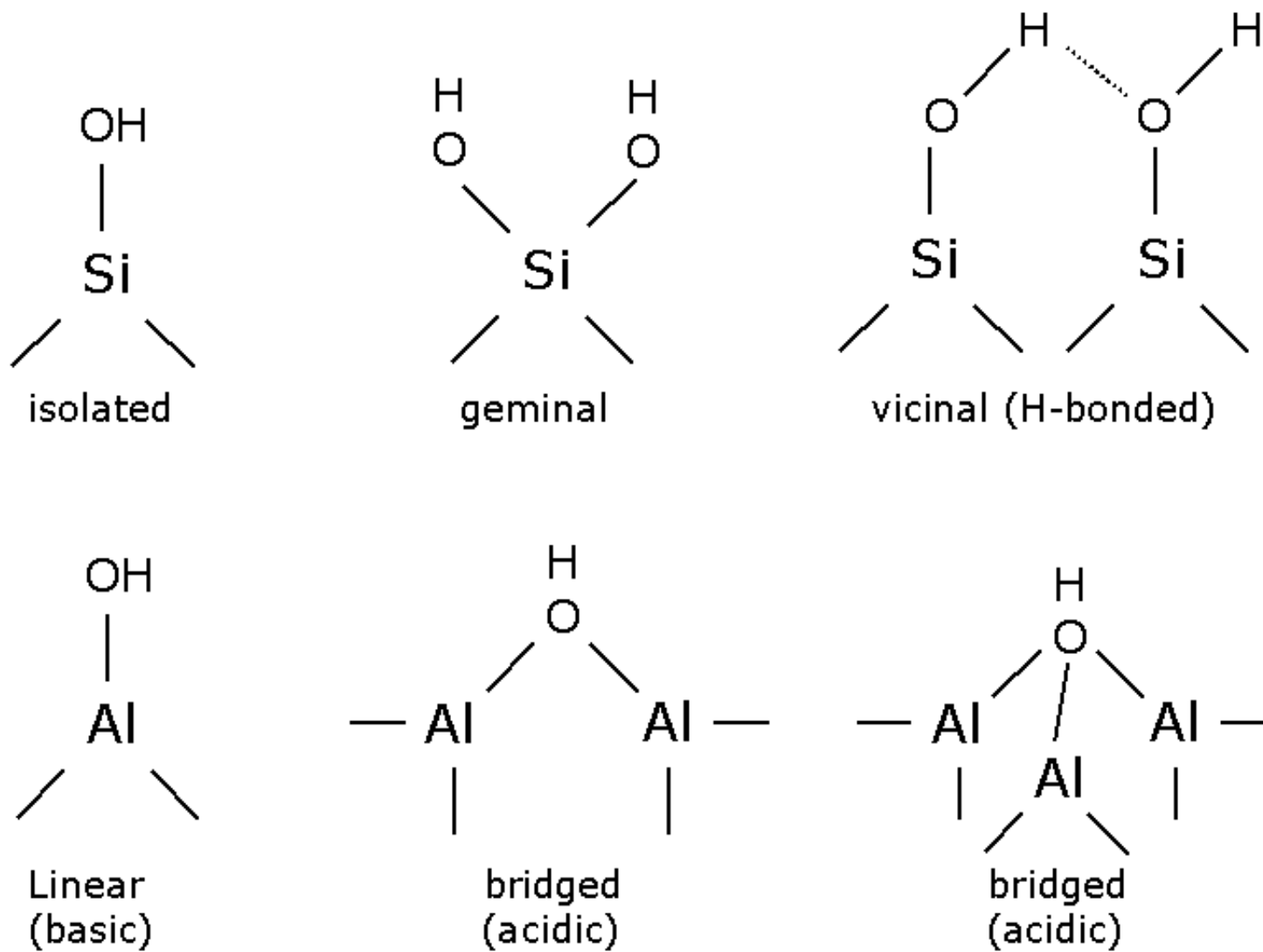


Figure 5.24





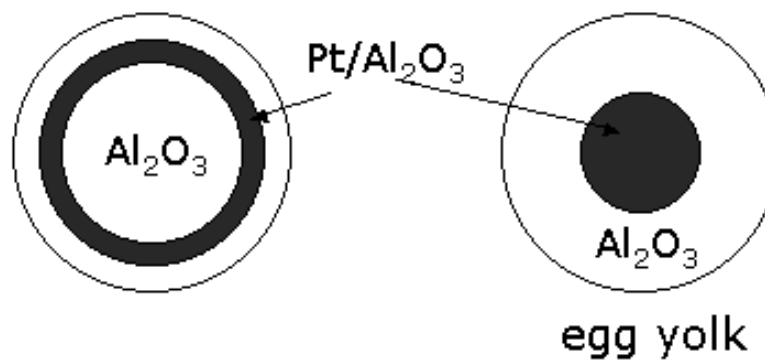
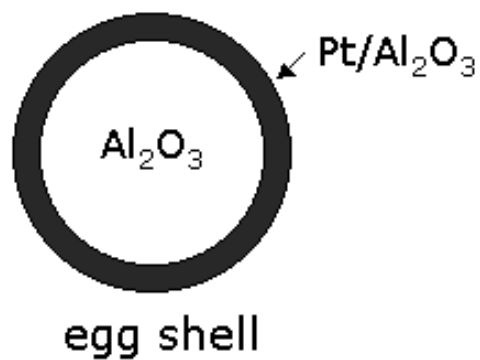
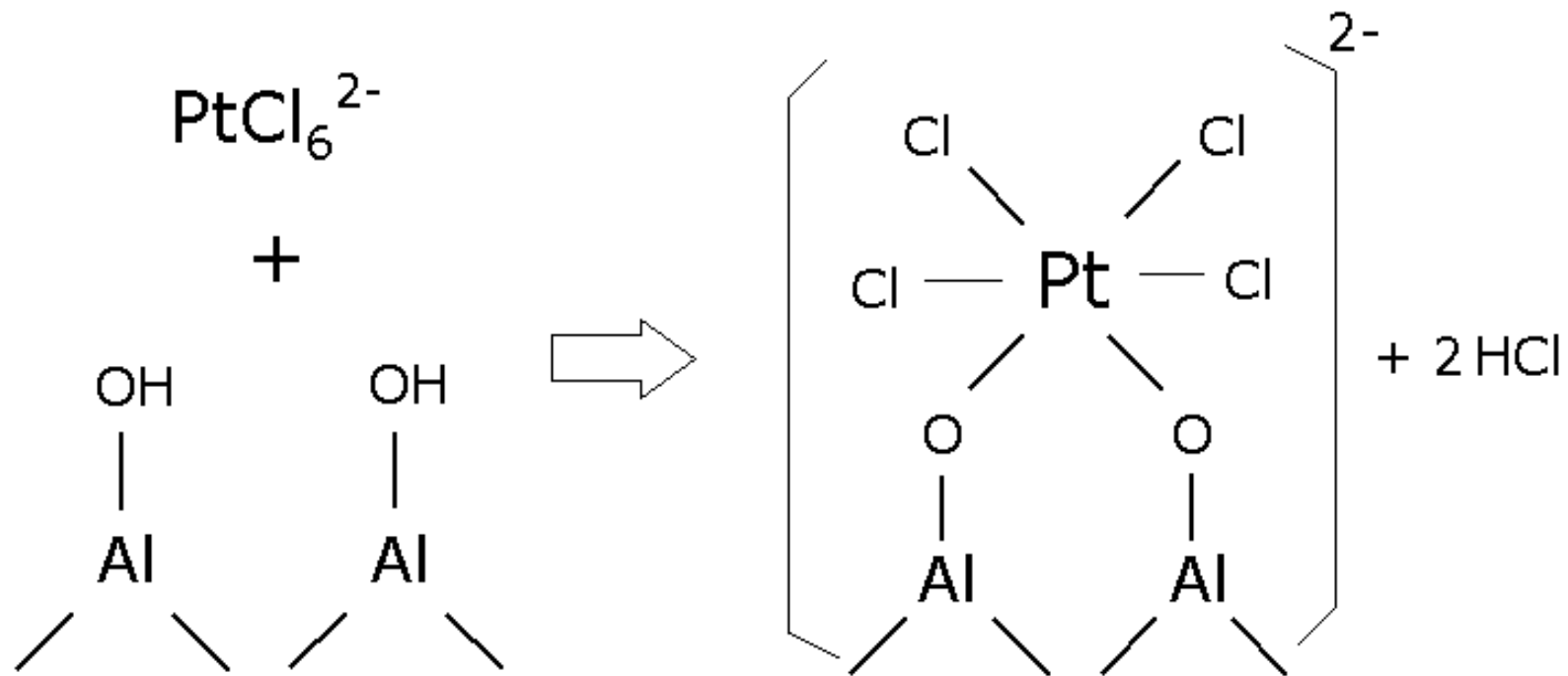


Figure 5.27

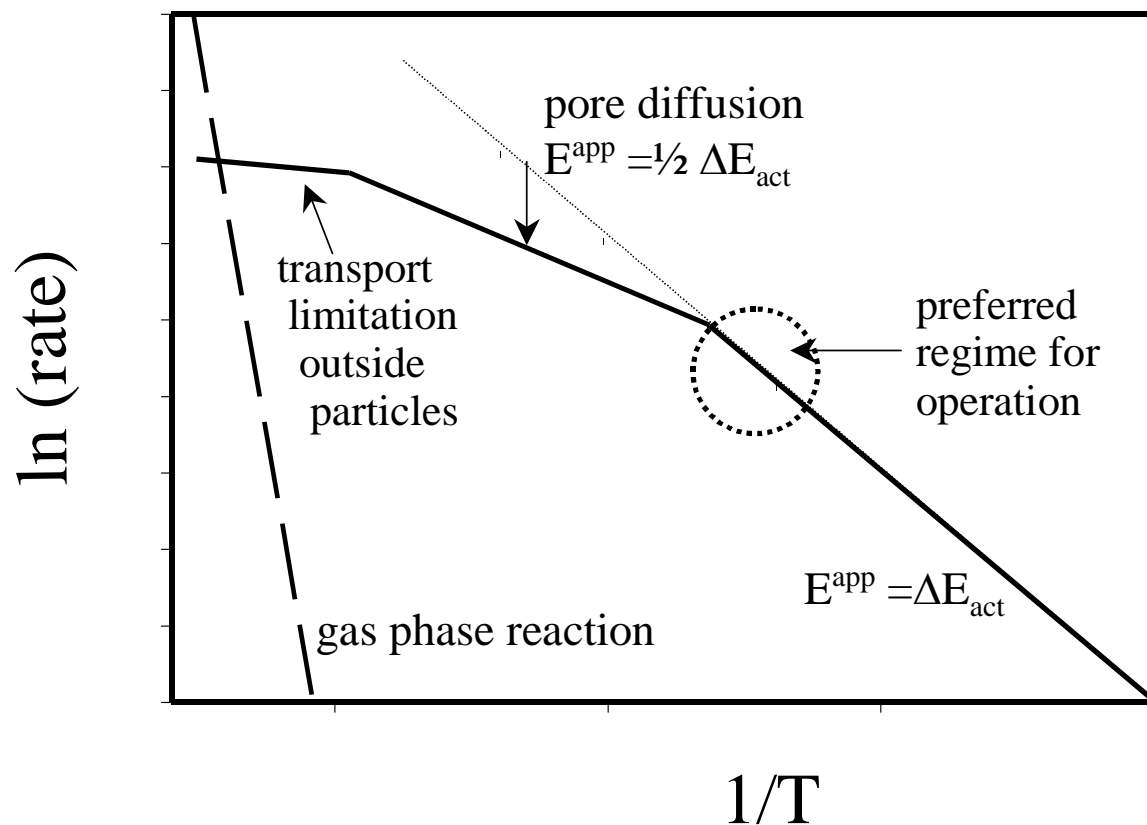


Figure 5.37

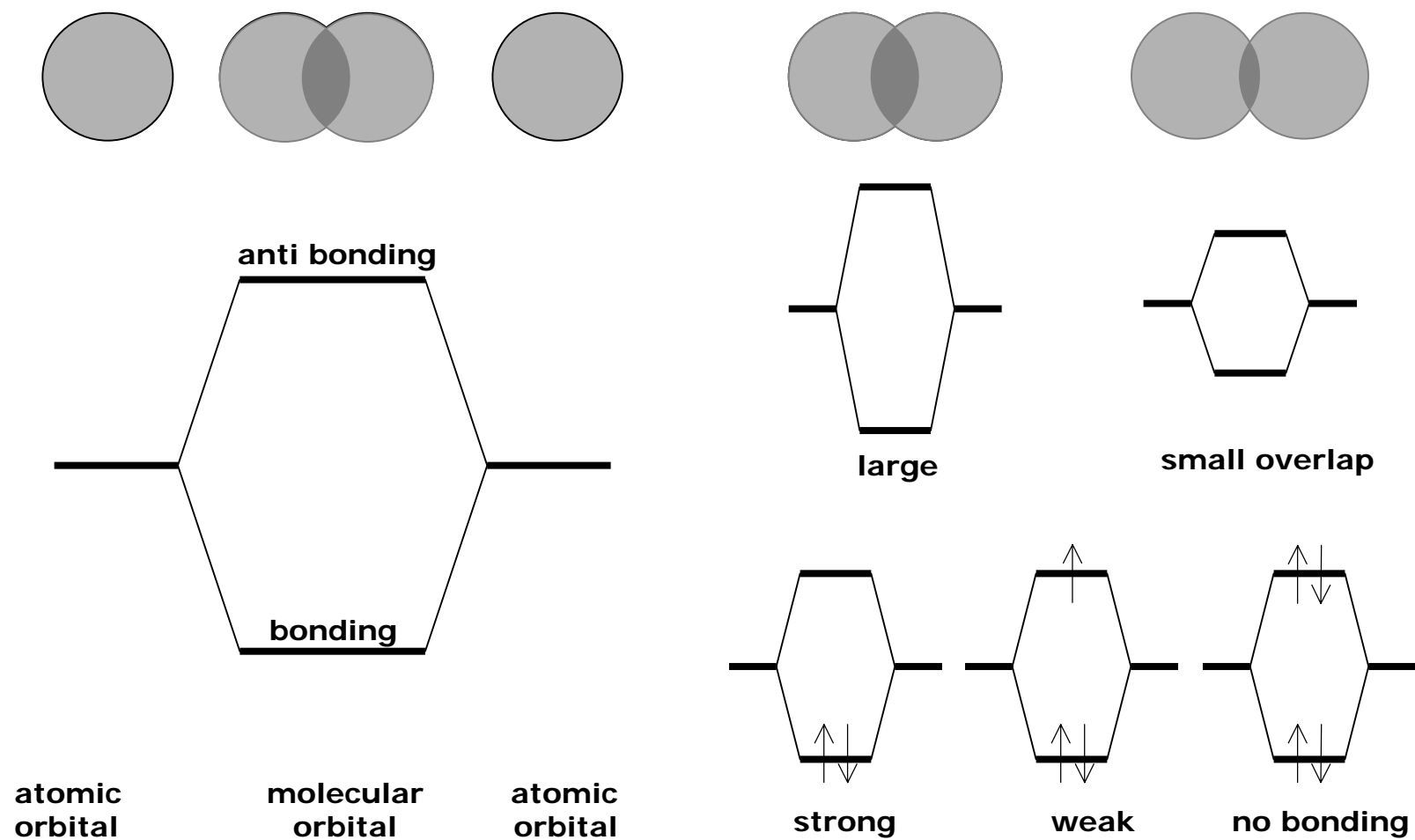


Figure 6.8

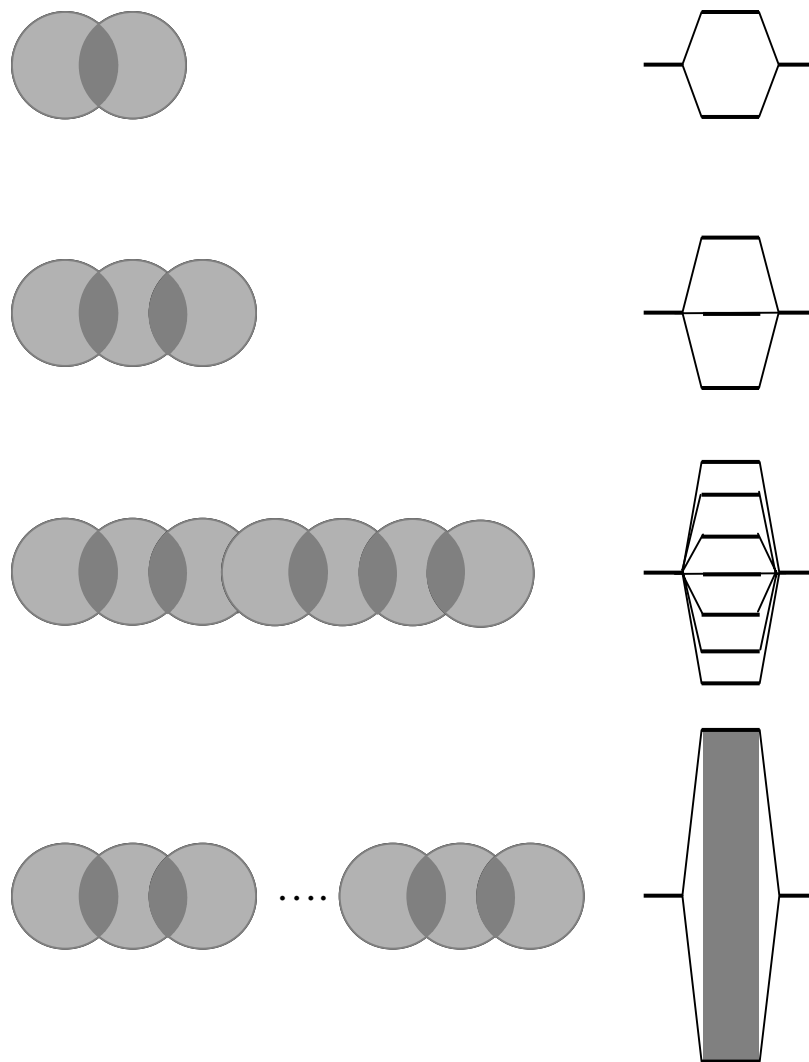


Figure 6.9

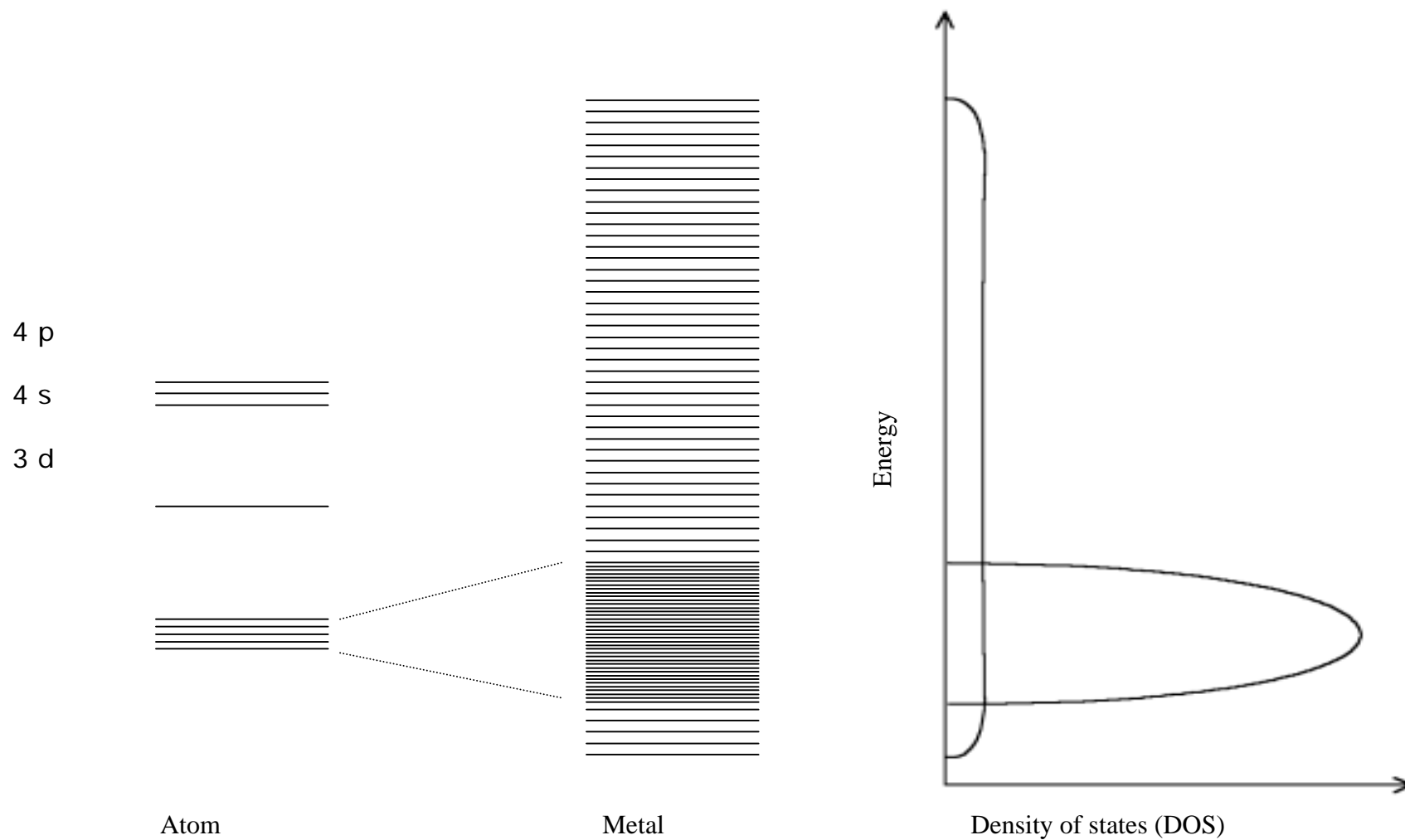


Figure 6.10

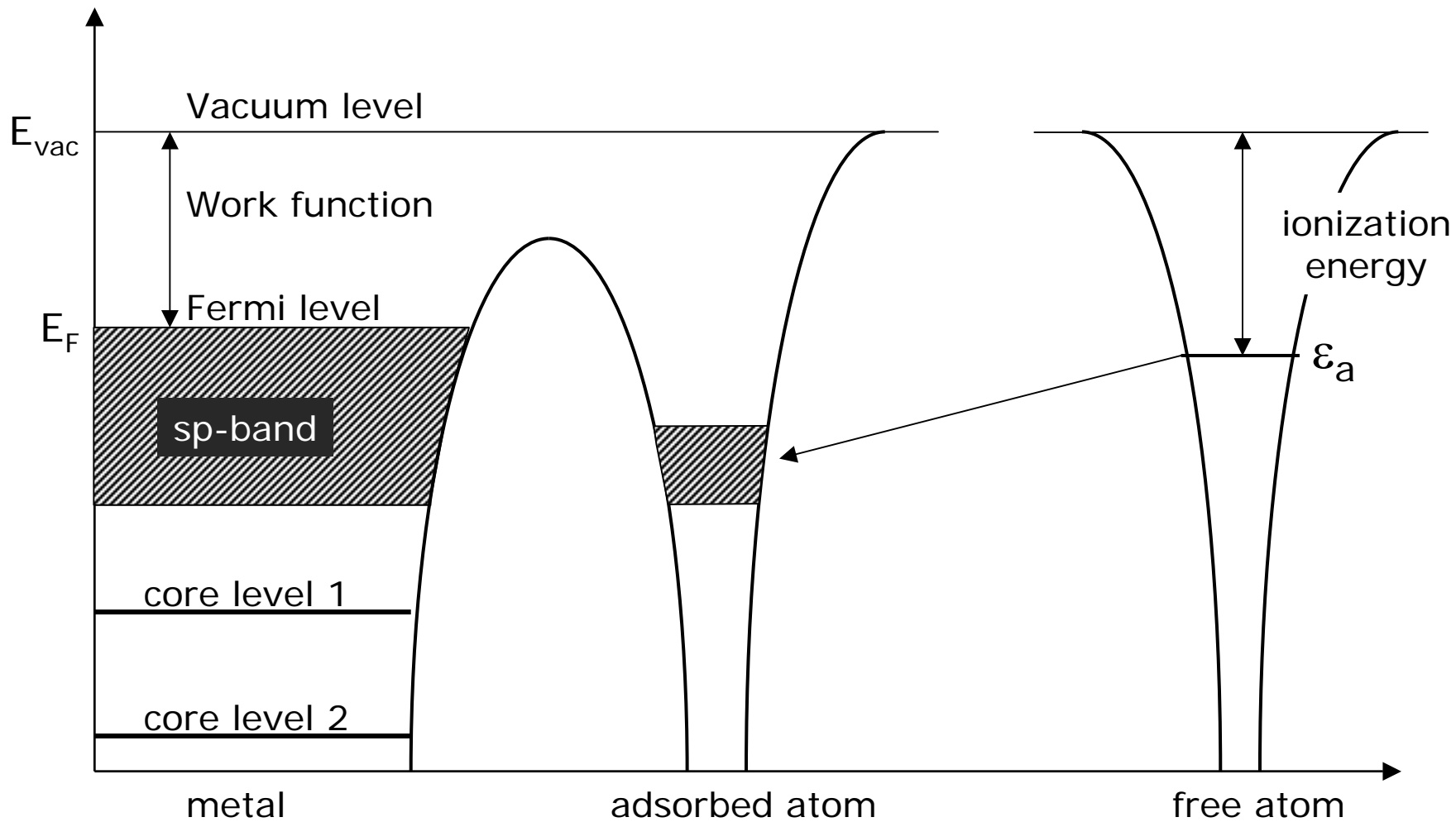
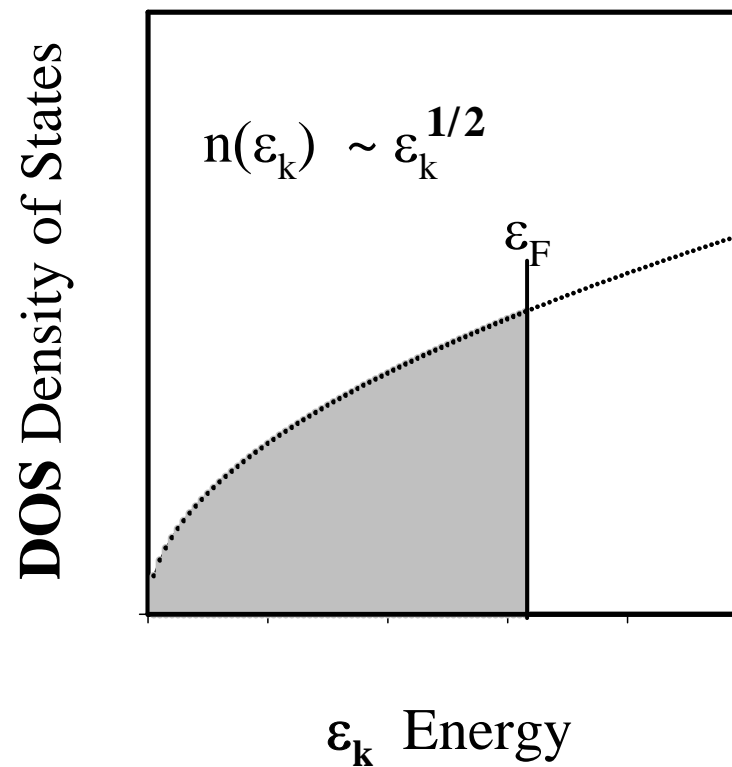
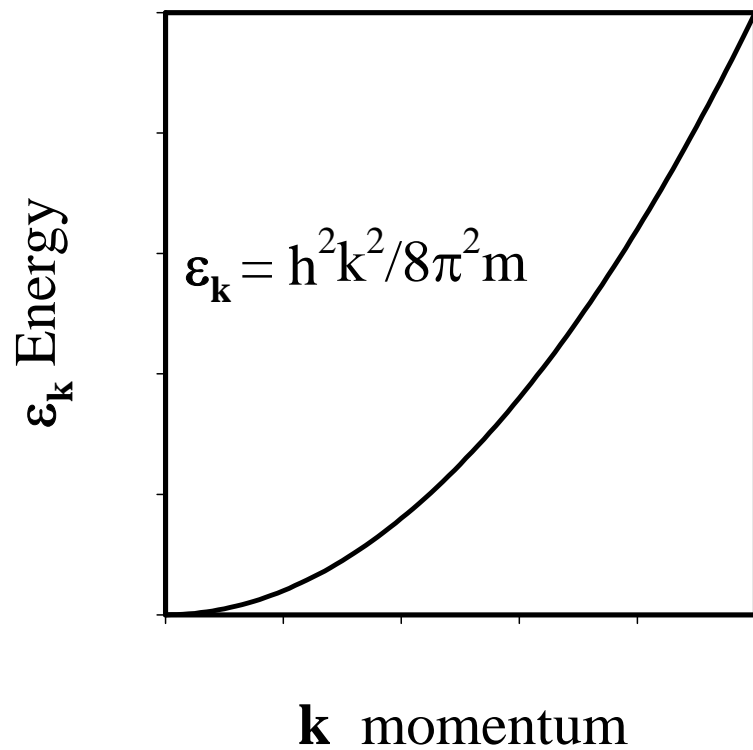


Figure 6.11



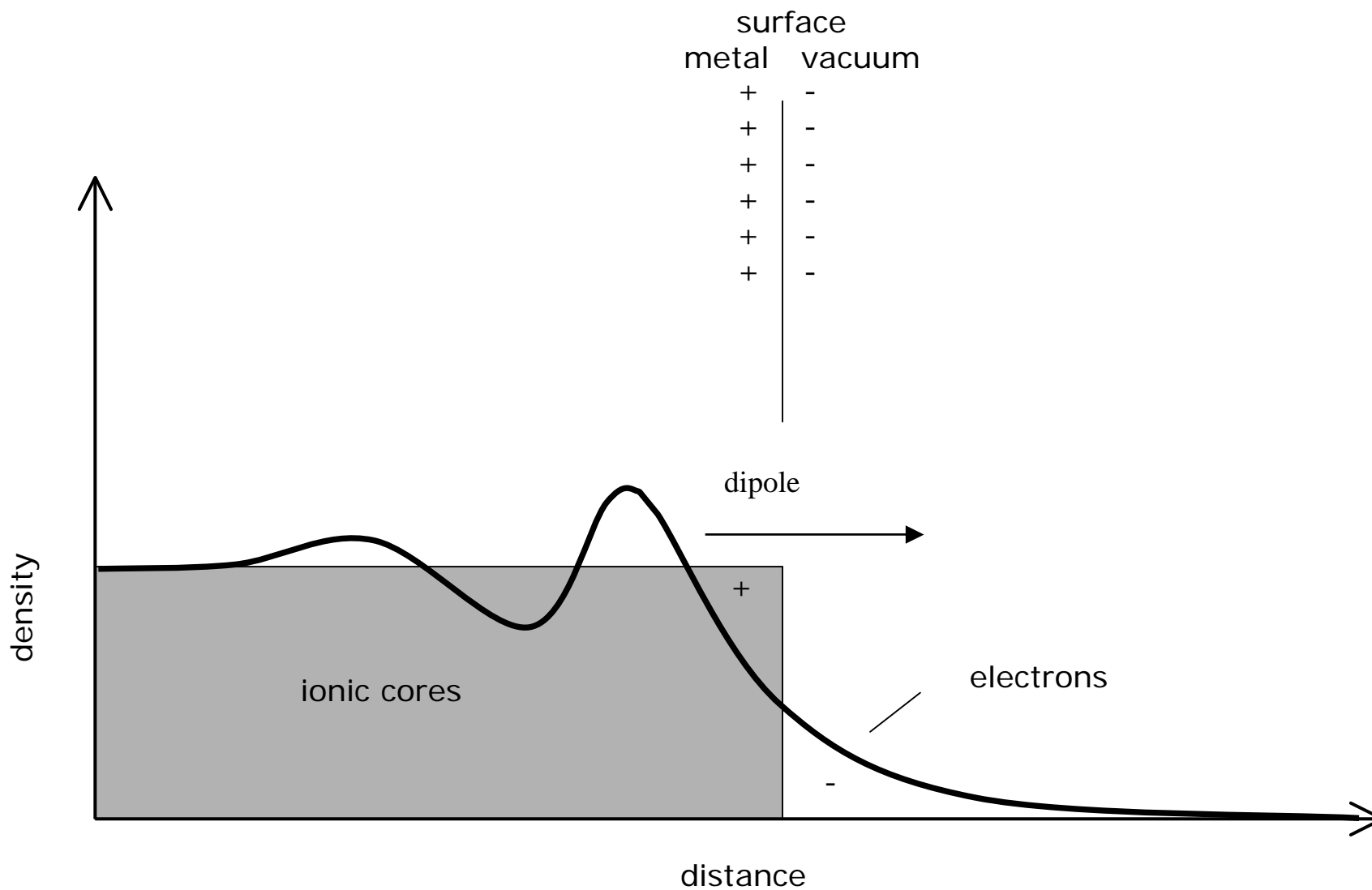
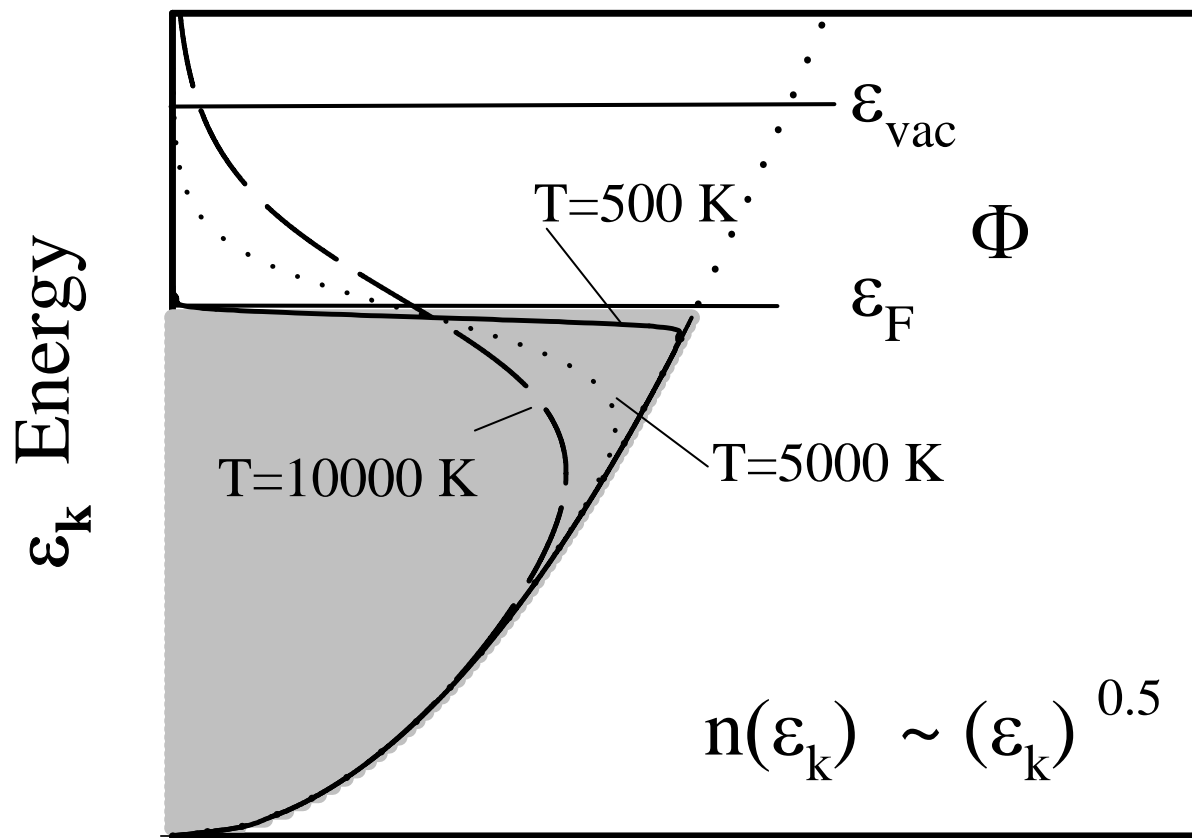


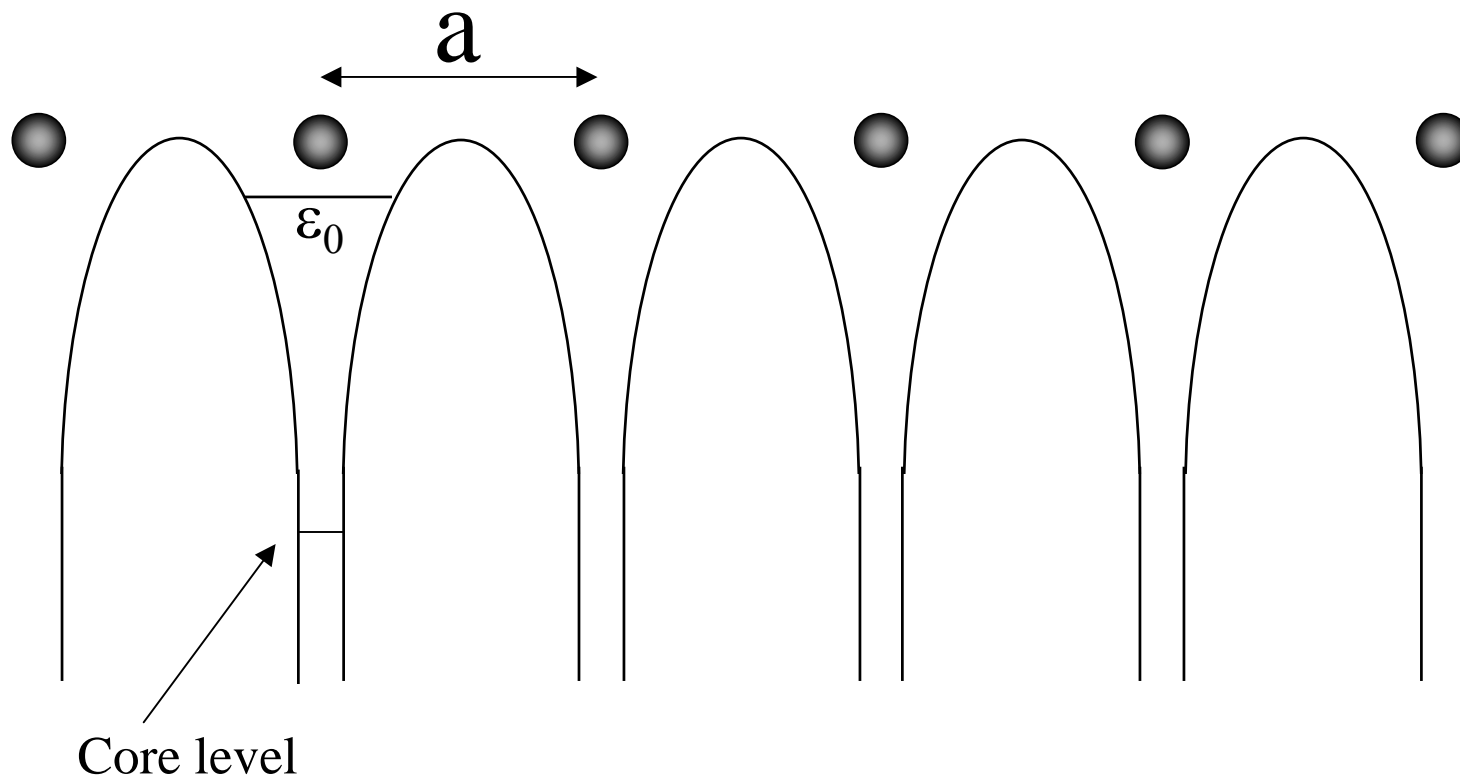
Figure 6.13

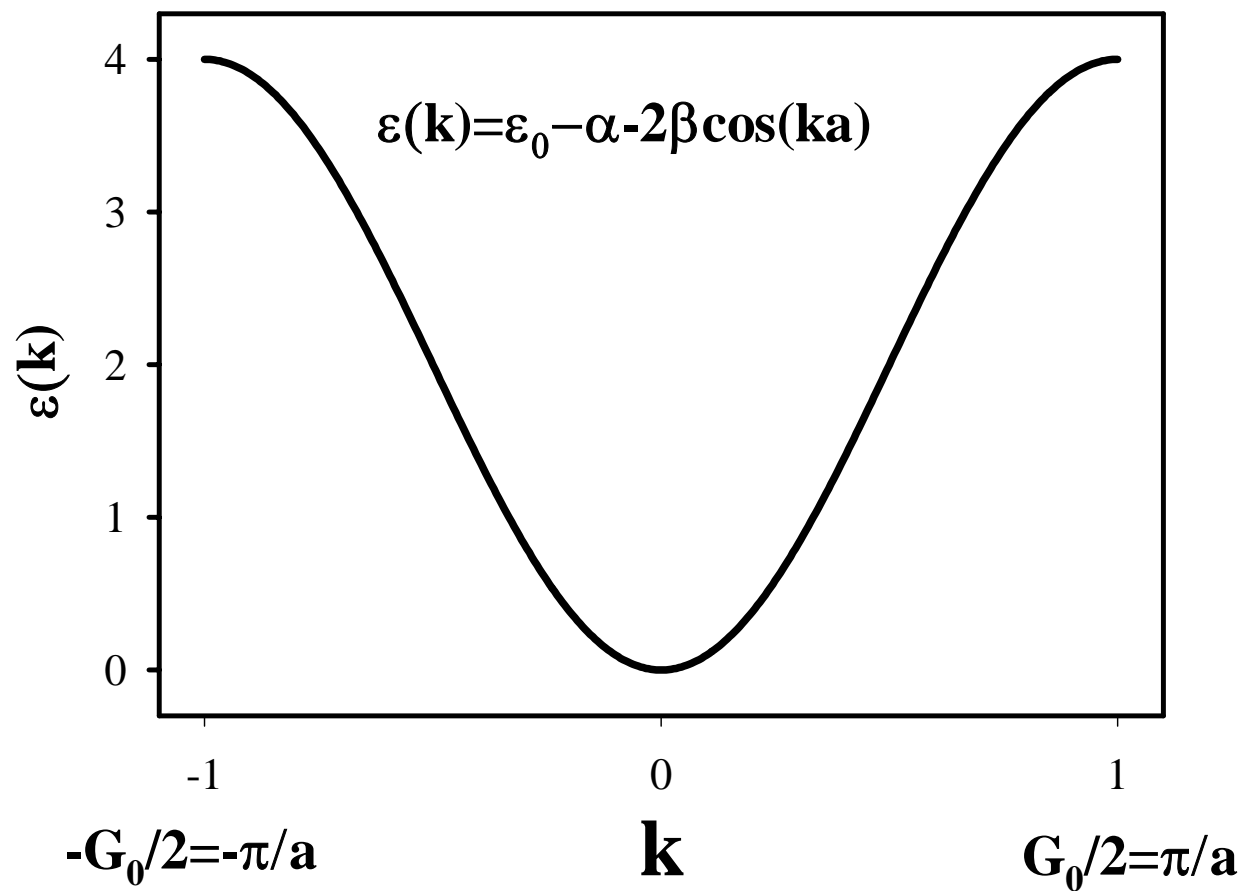




## DOS Density of States







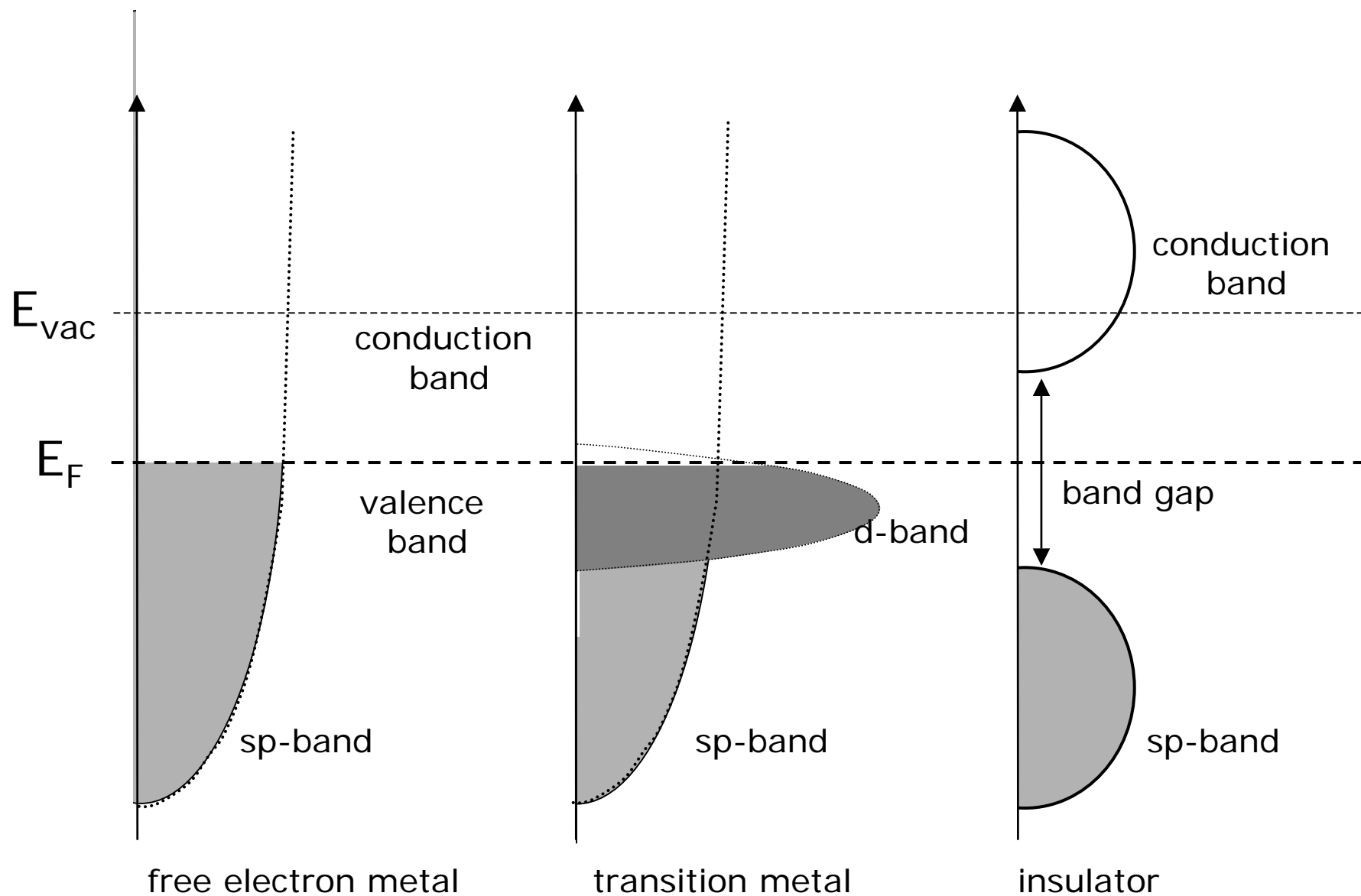


Figure 6.17

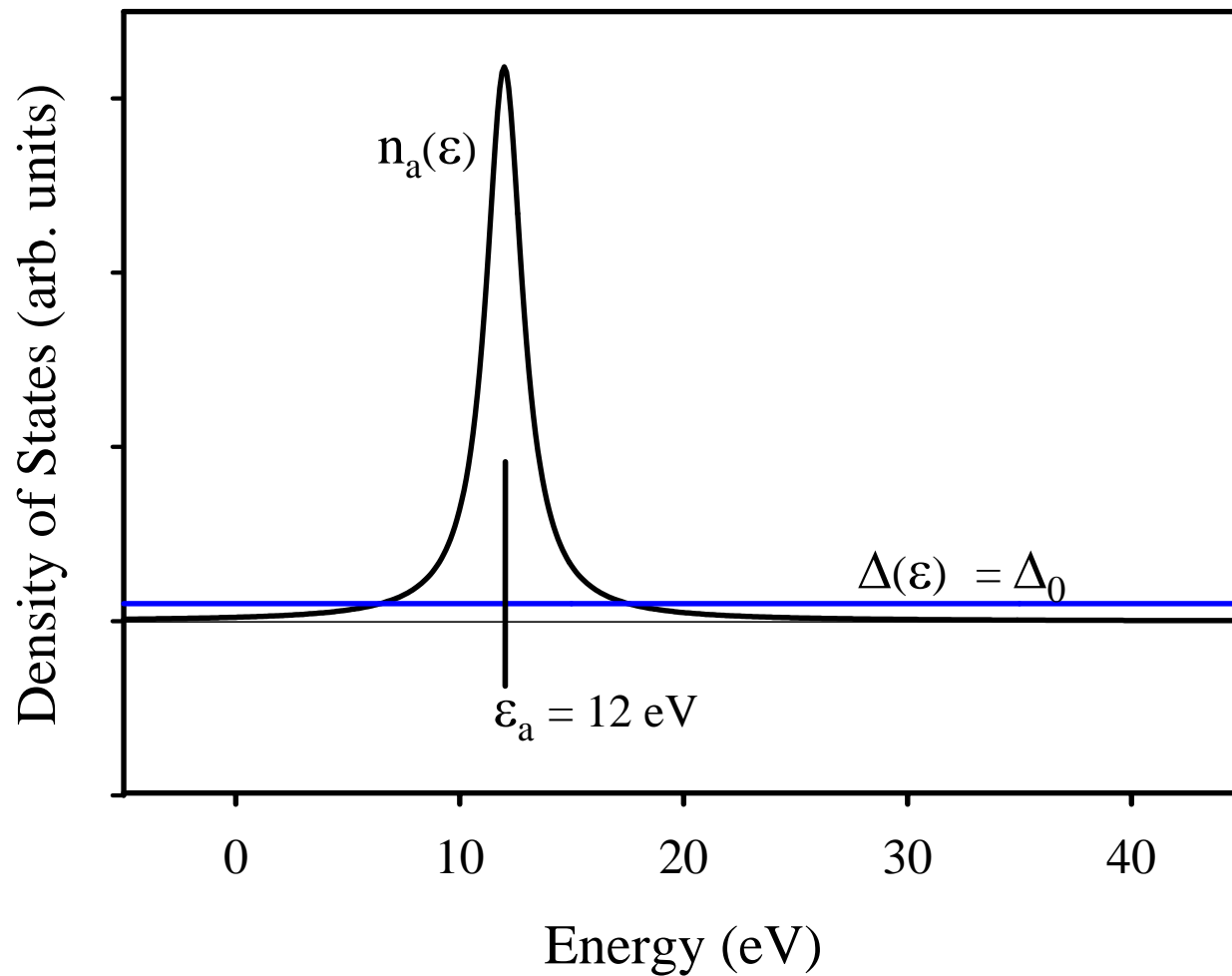


Figure 6.20

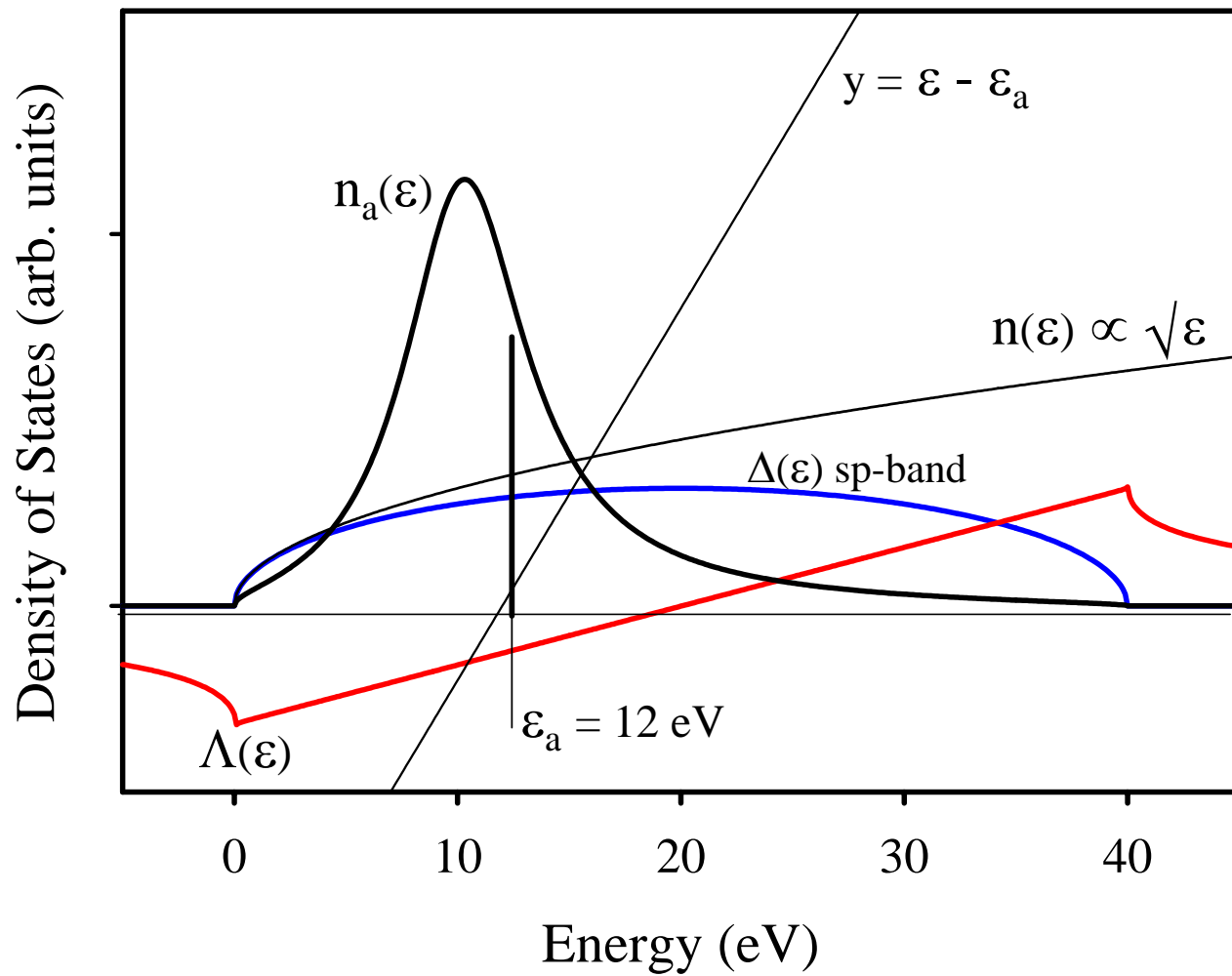


Figure 6.21

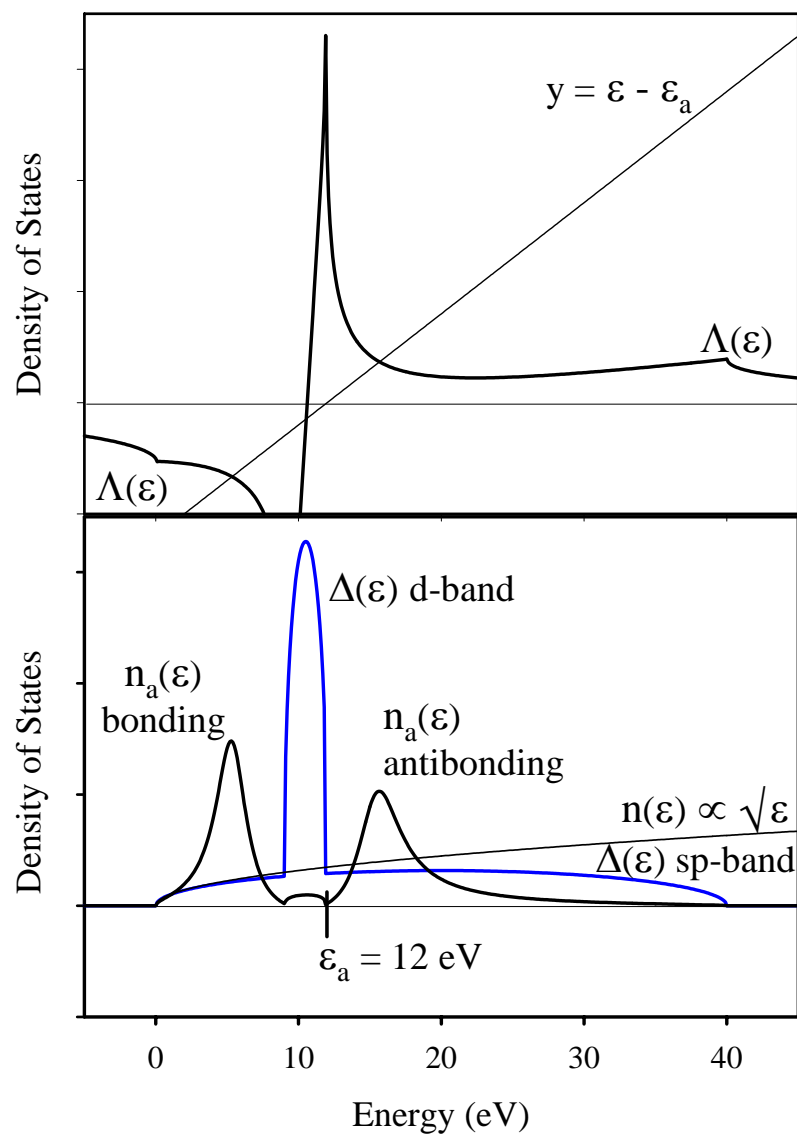
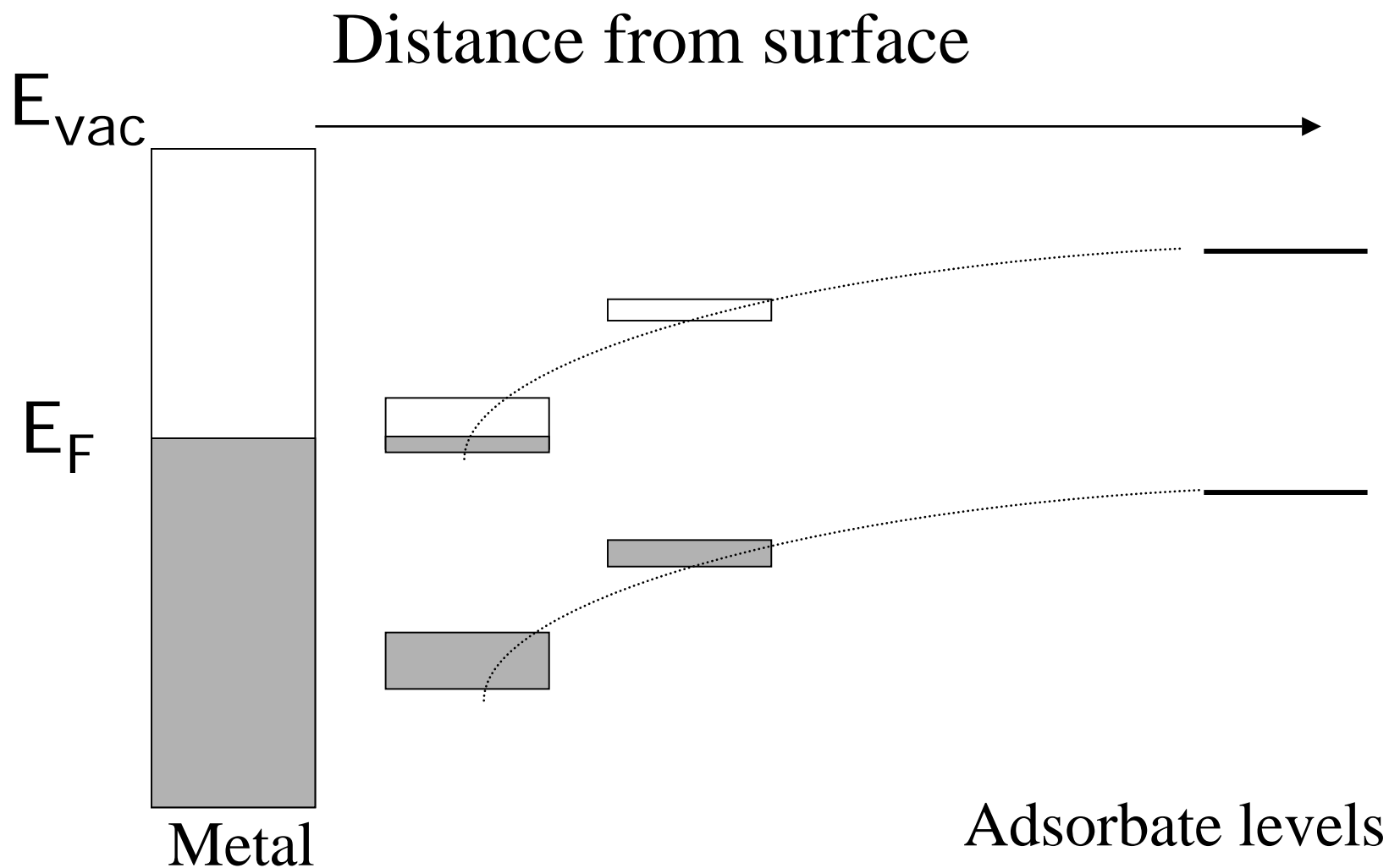


Figure 6.22





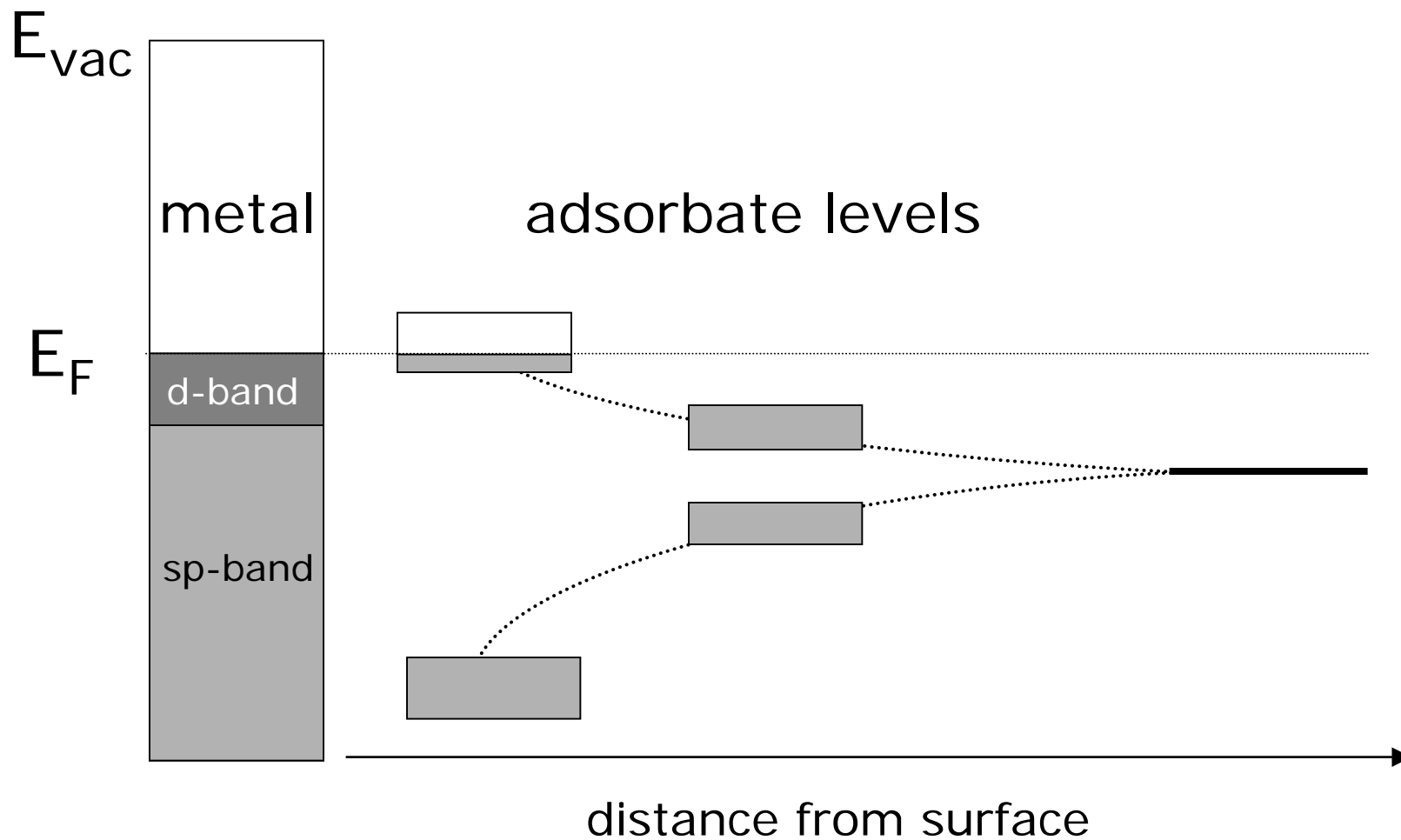


Figure 6.24

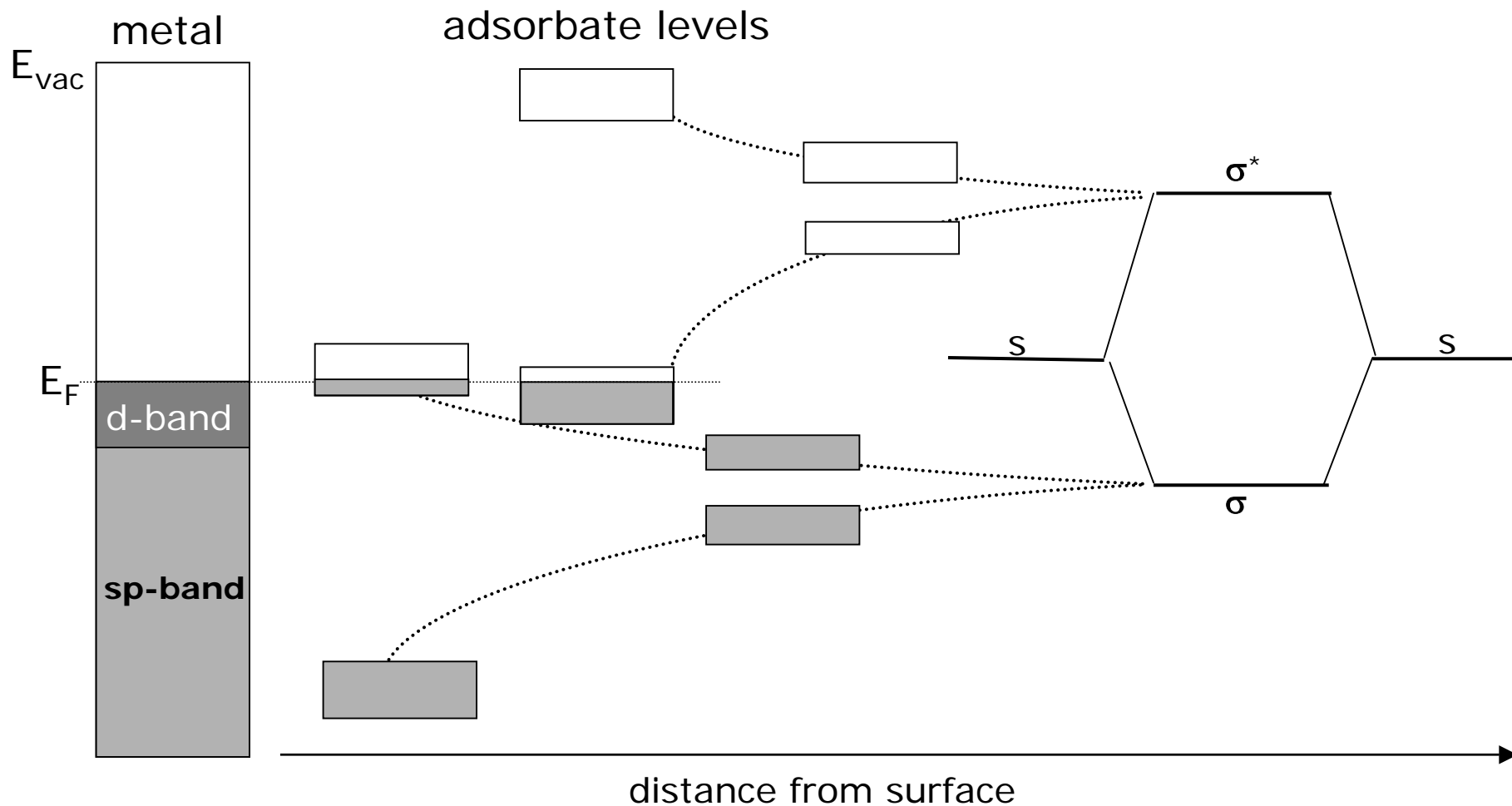


Figure 6.25

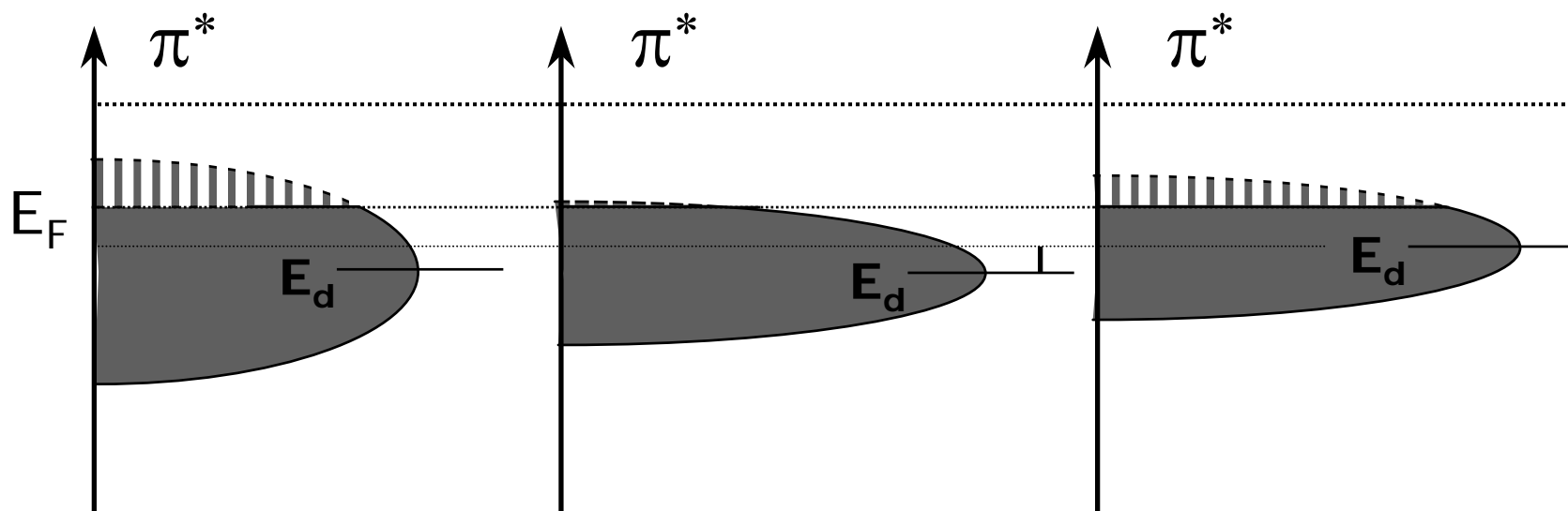
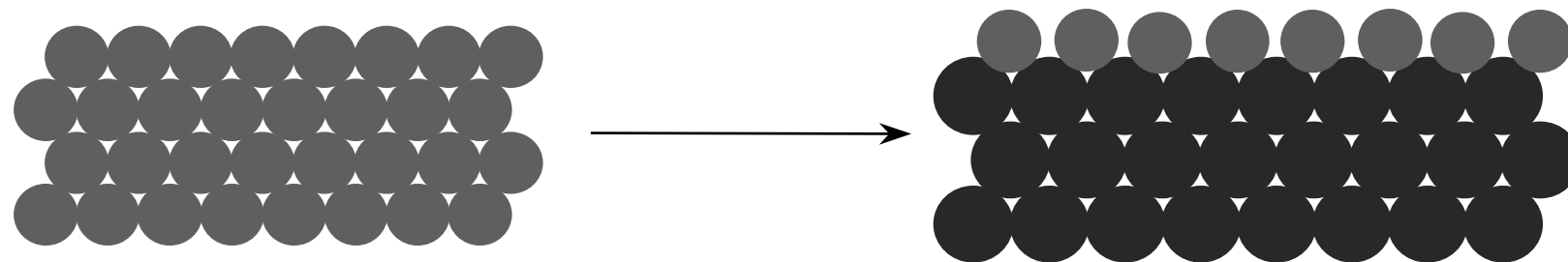
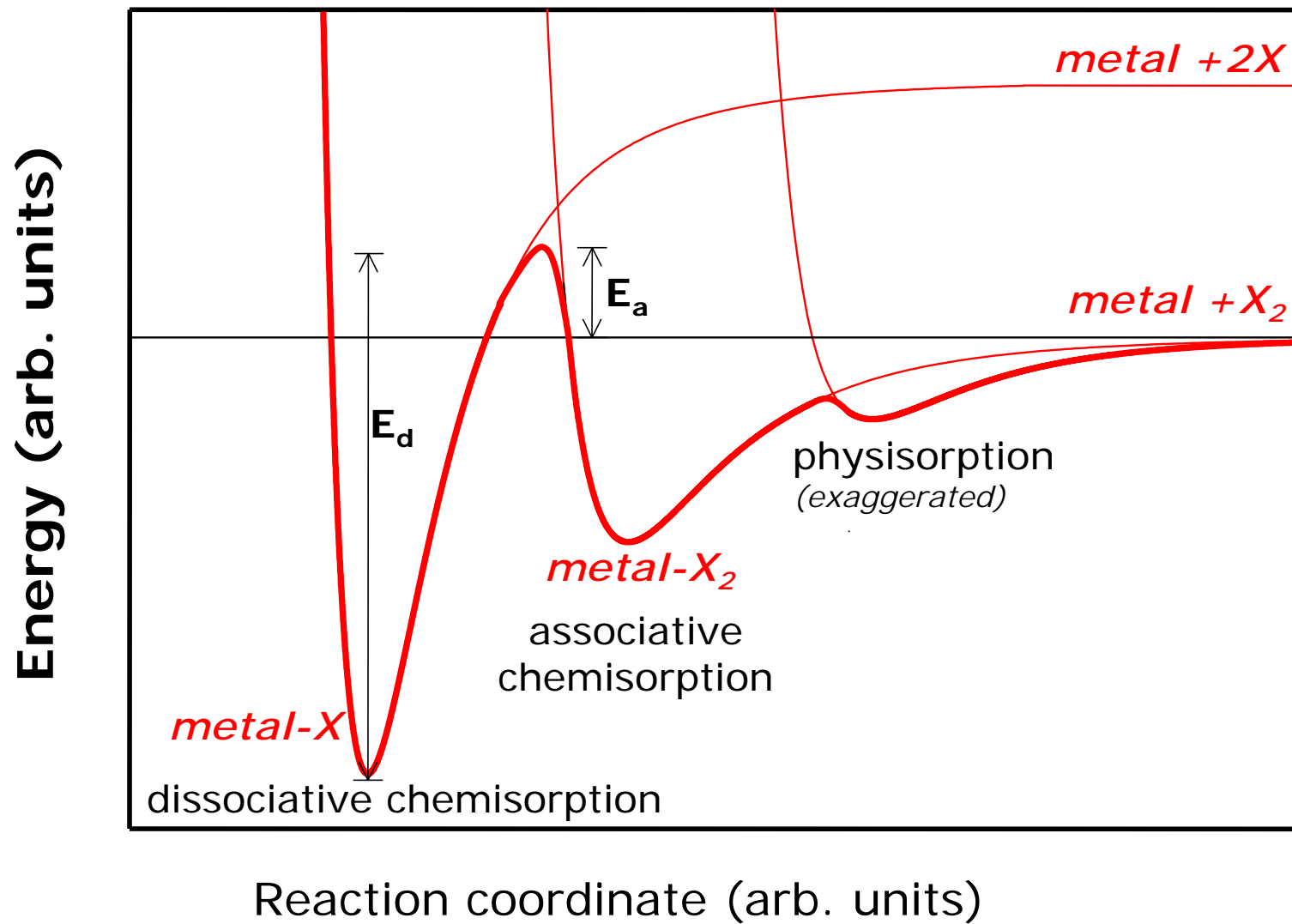
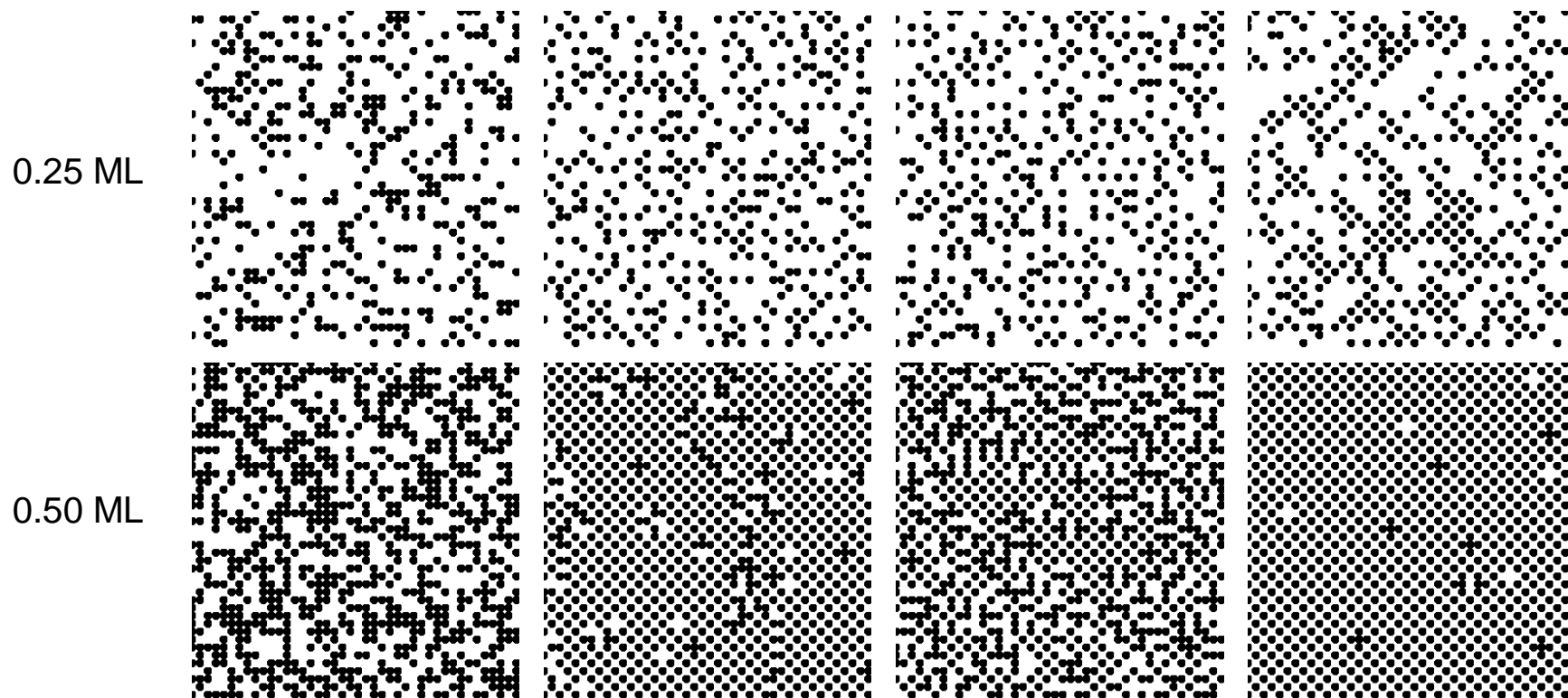
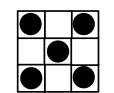
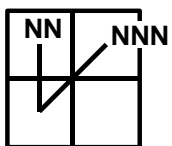


Figure 6.33





$\omega_{A-A}^{NN} =$	0	10	10	10 kJ/mol
$\omega_{A-A}^{NNN} =$	0	0	3	-3 kJ/mol



C(2x2)



(2x2)



(1x1)



Figure 7.9

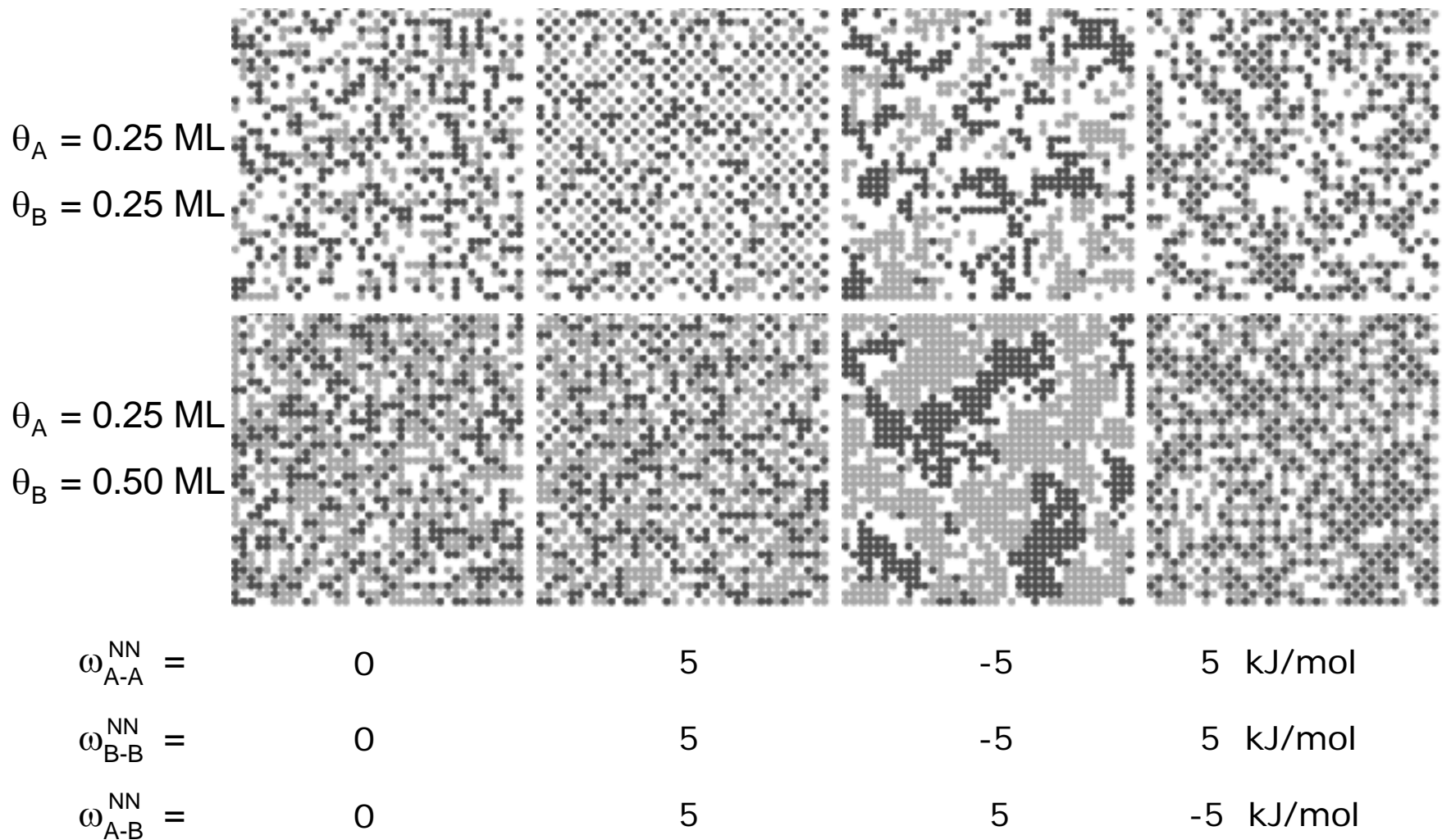
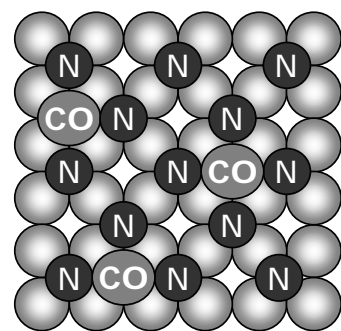
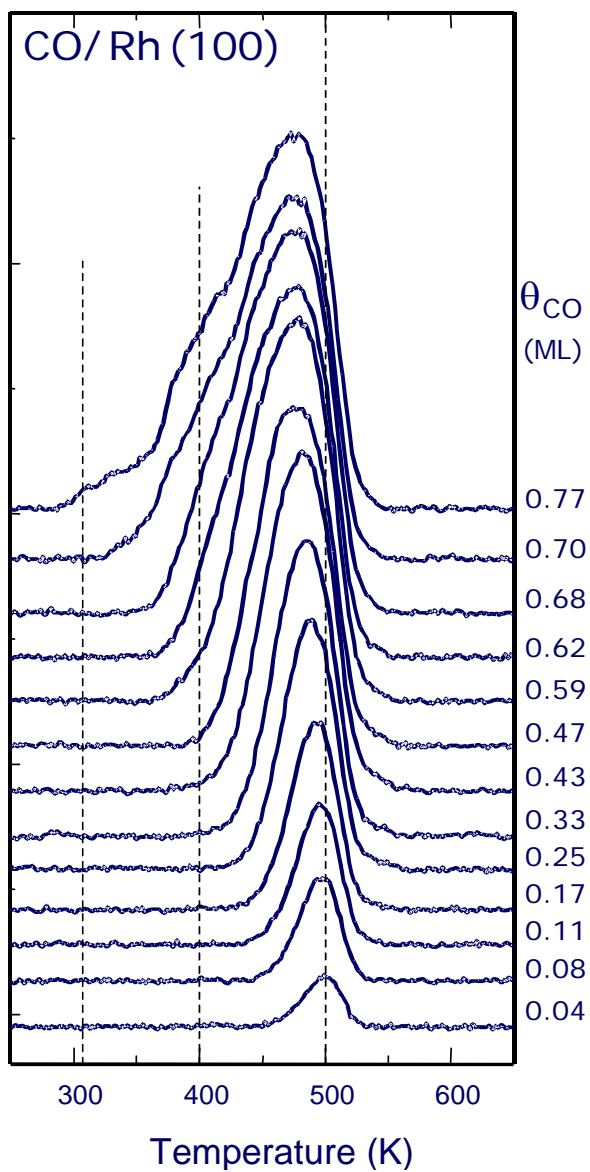
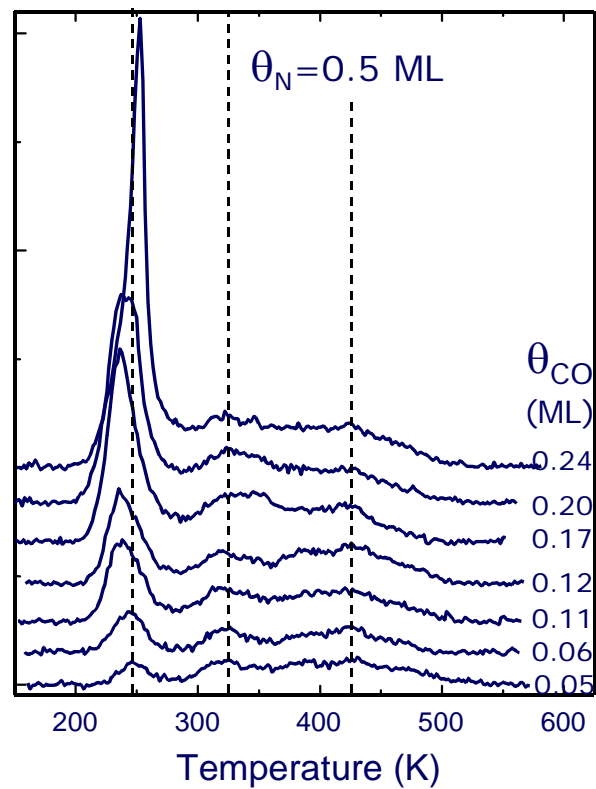


Figure 7.10



CO + c(2x2)-N/Rh(100)



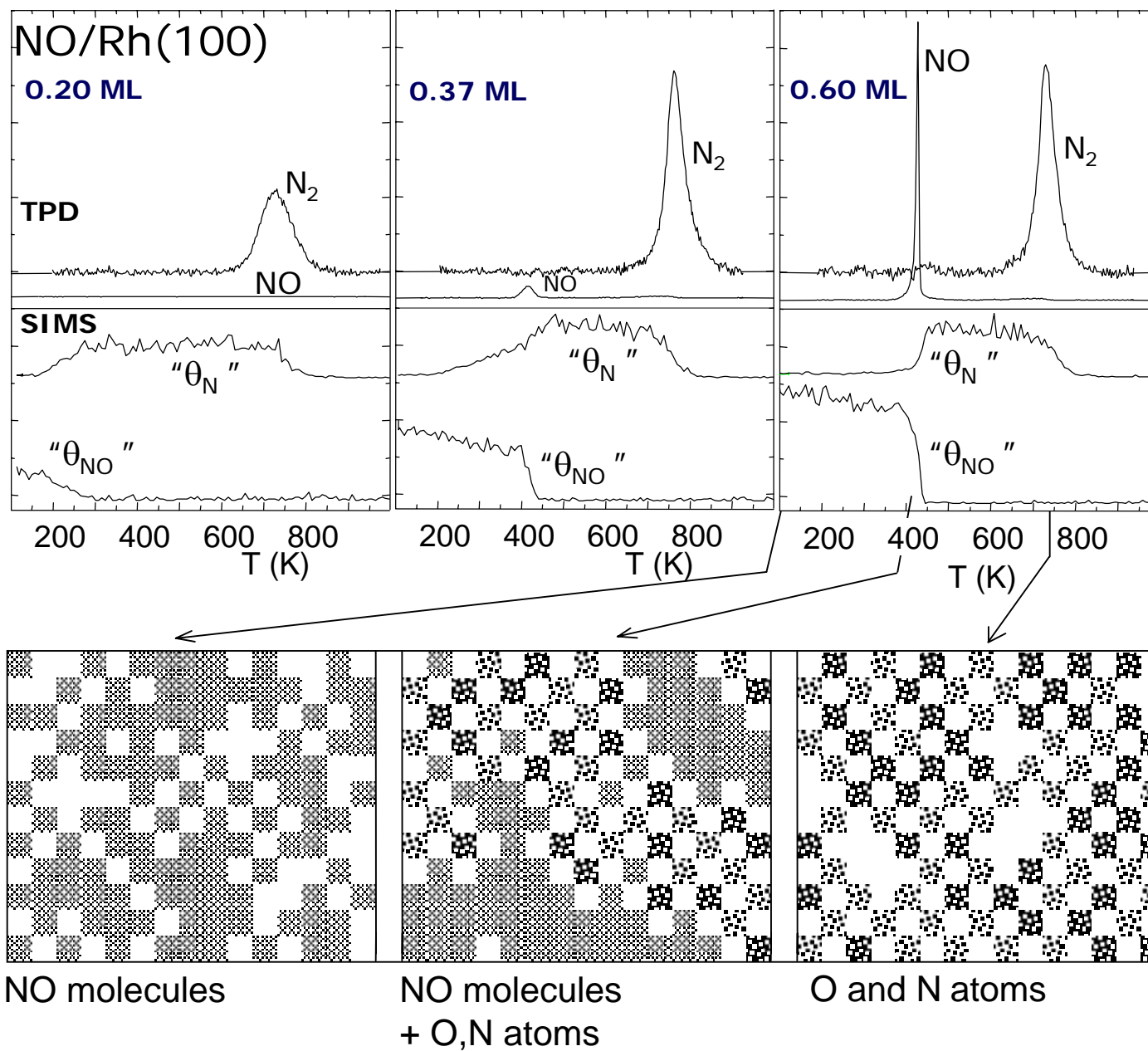
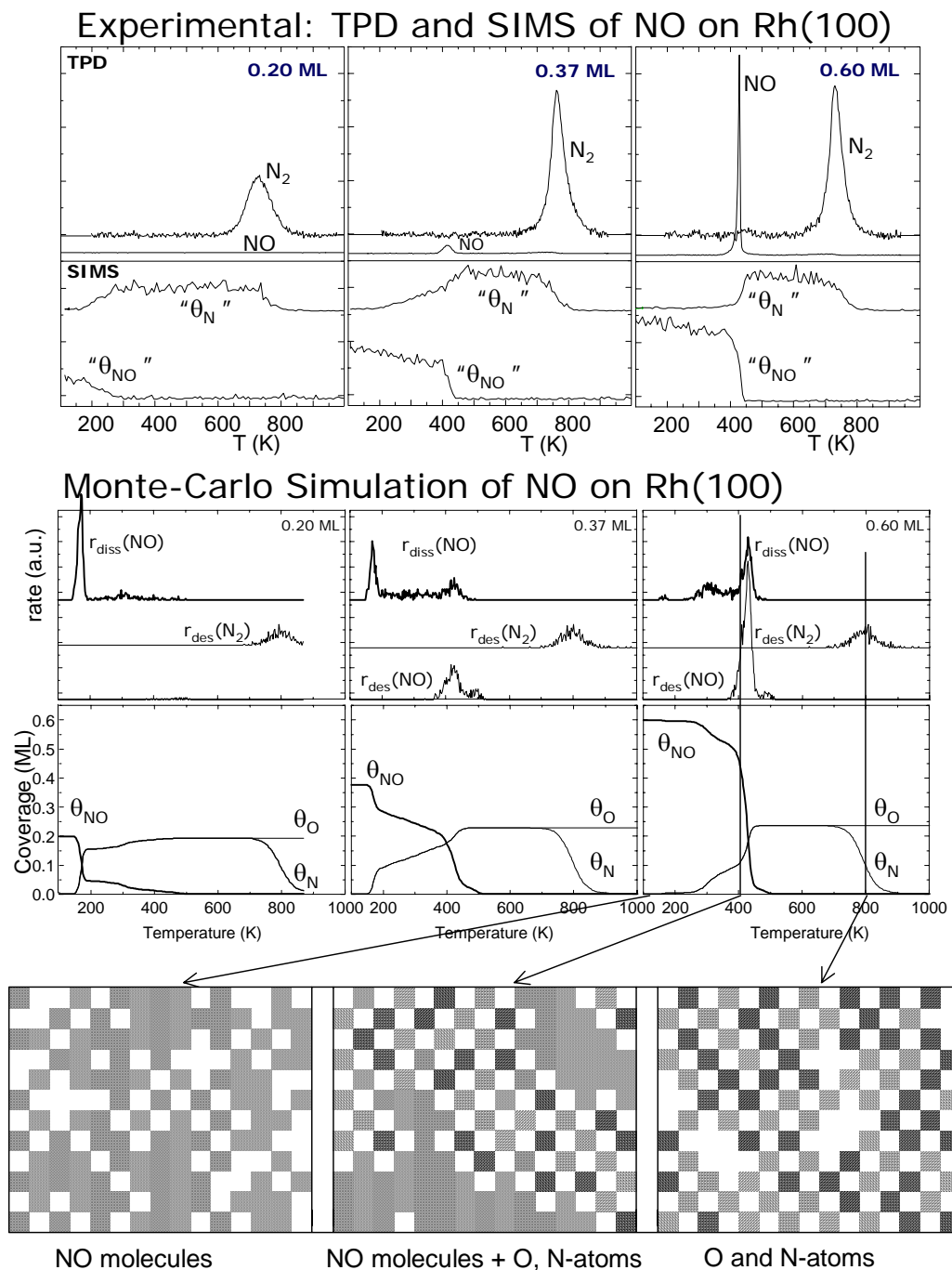






Figure 7.12 - extra



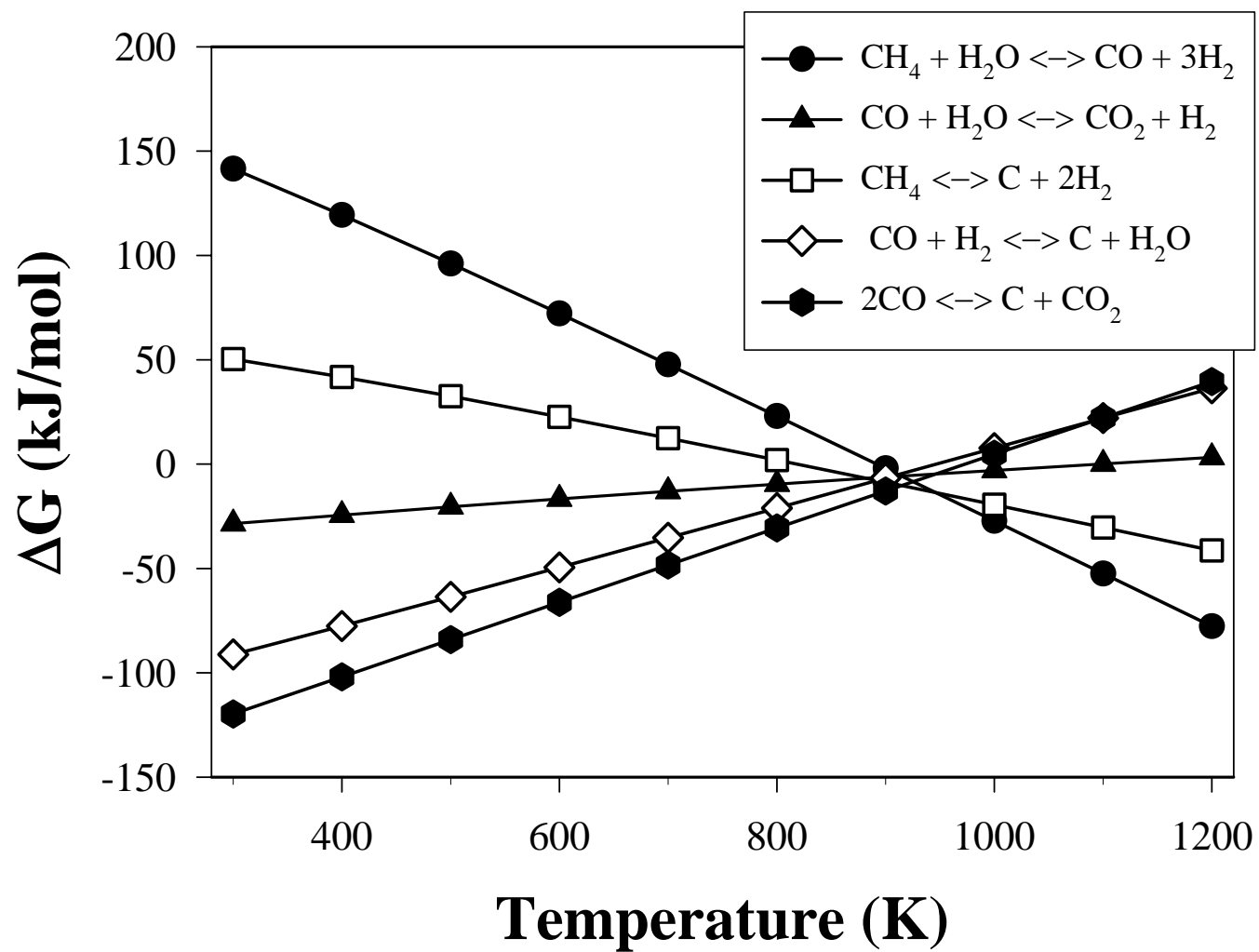
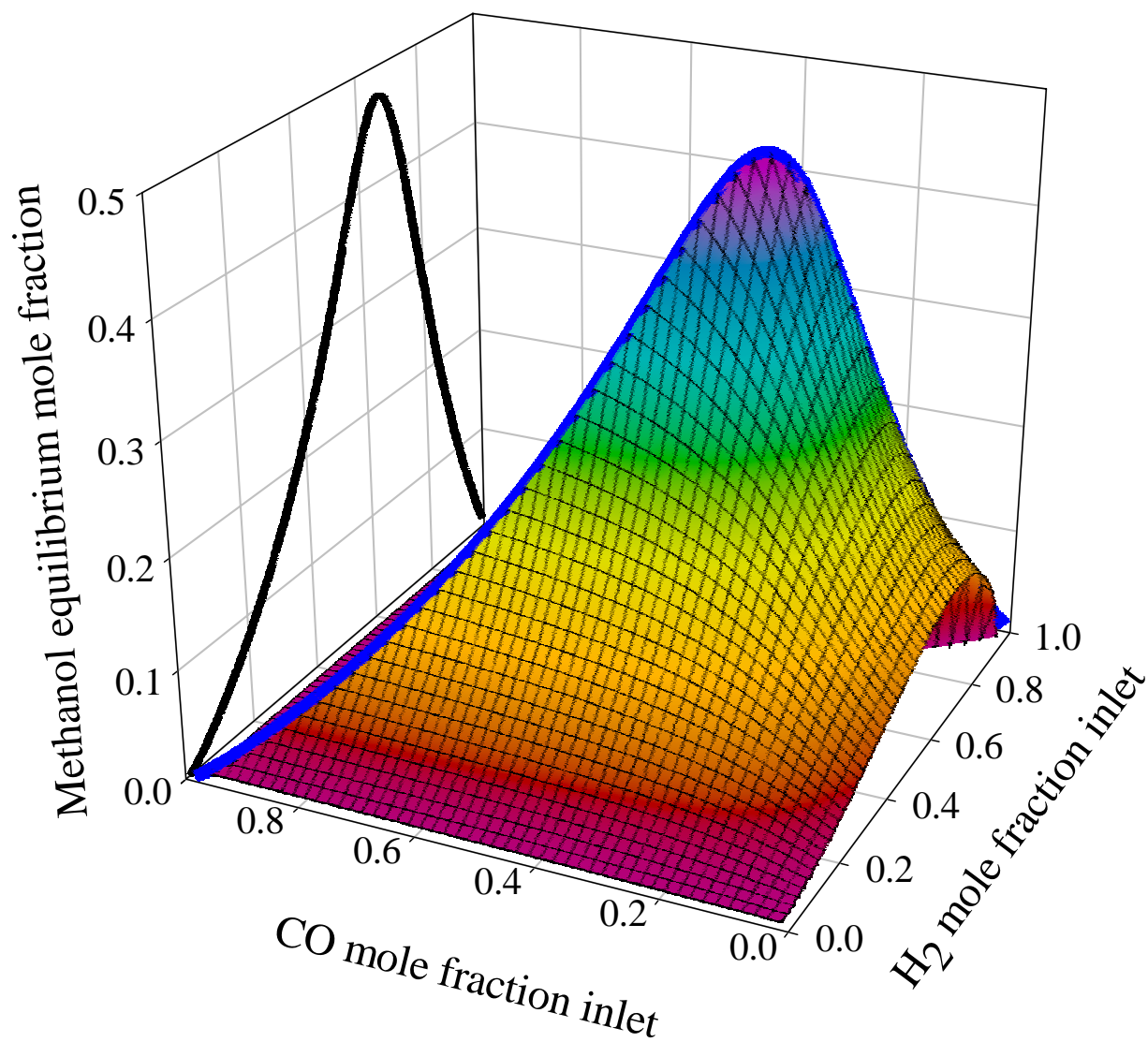


Figure 8.1





*Concepts of Modern Catalysis and Kinetics*. I. Chorkendorff, J.W. Niemantsverdriet  
Copyright © 2003 WILEY-VCH Verlag GmbH & Co. KGaA, Weinheim  
ISBN: 3-527-30574-2

Figure 8.15

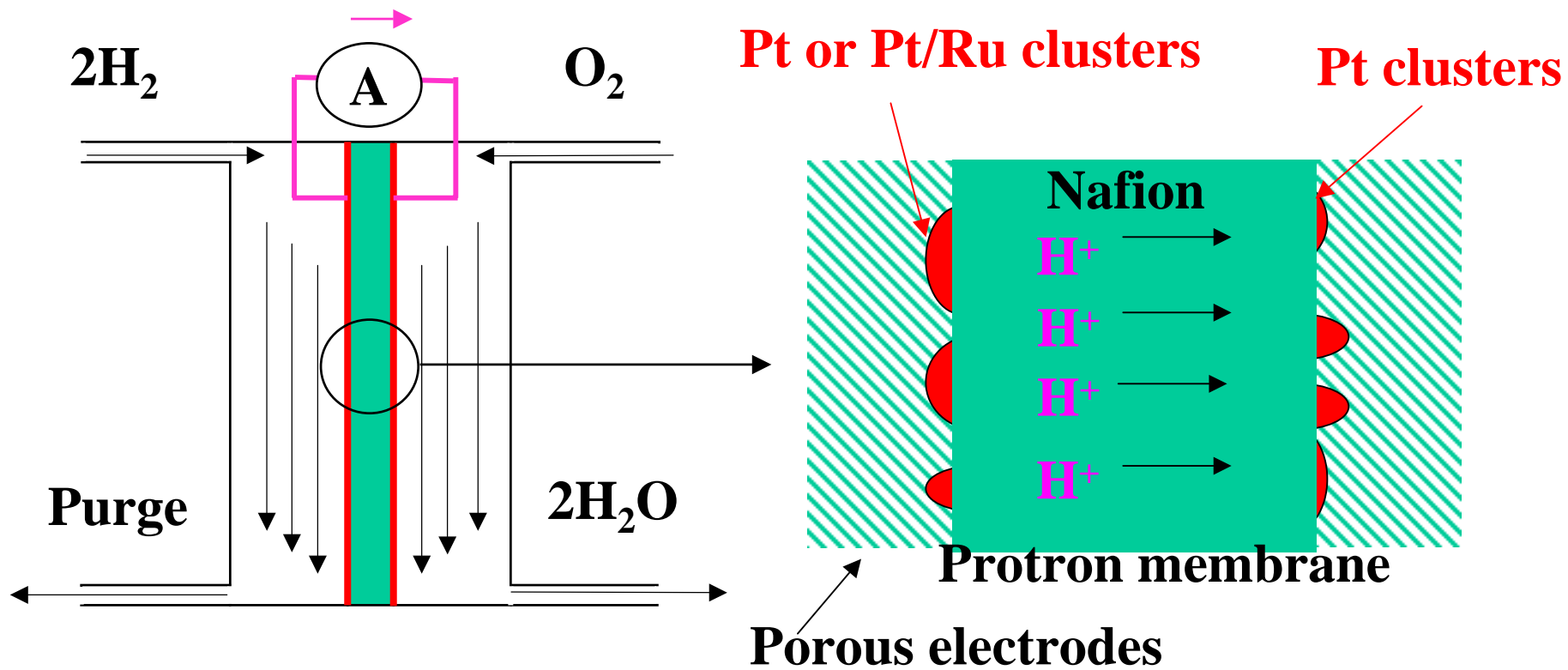
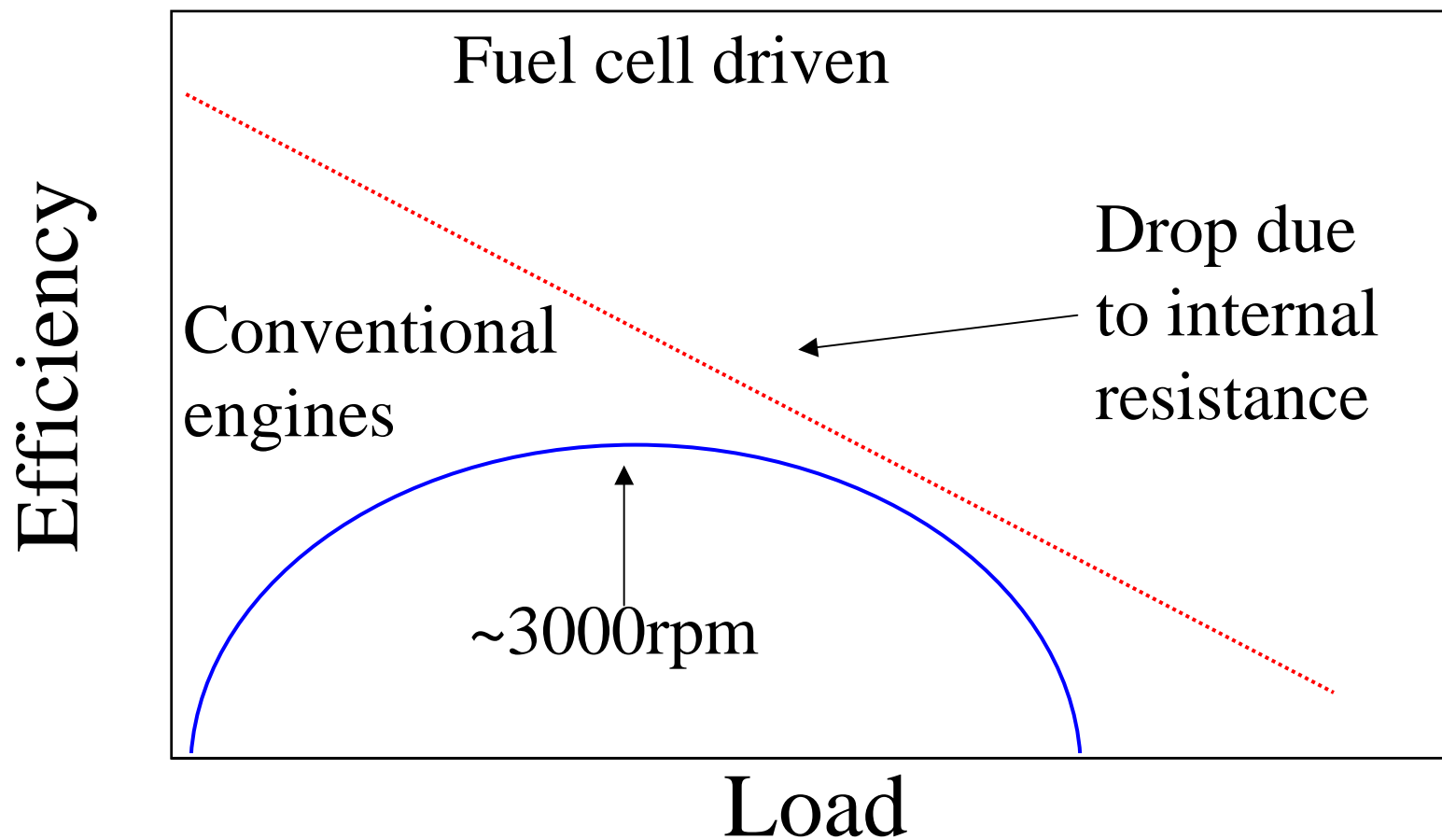


Figure 8.28



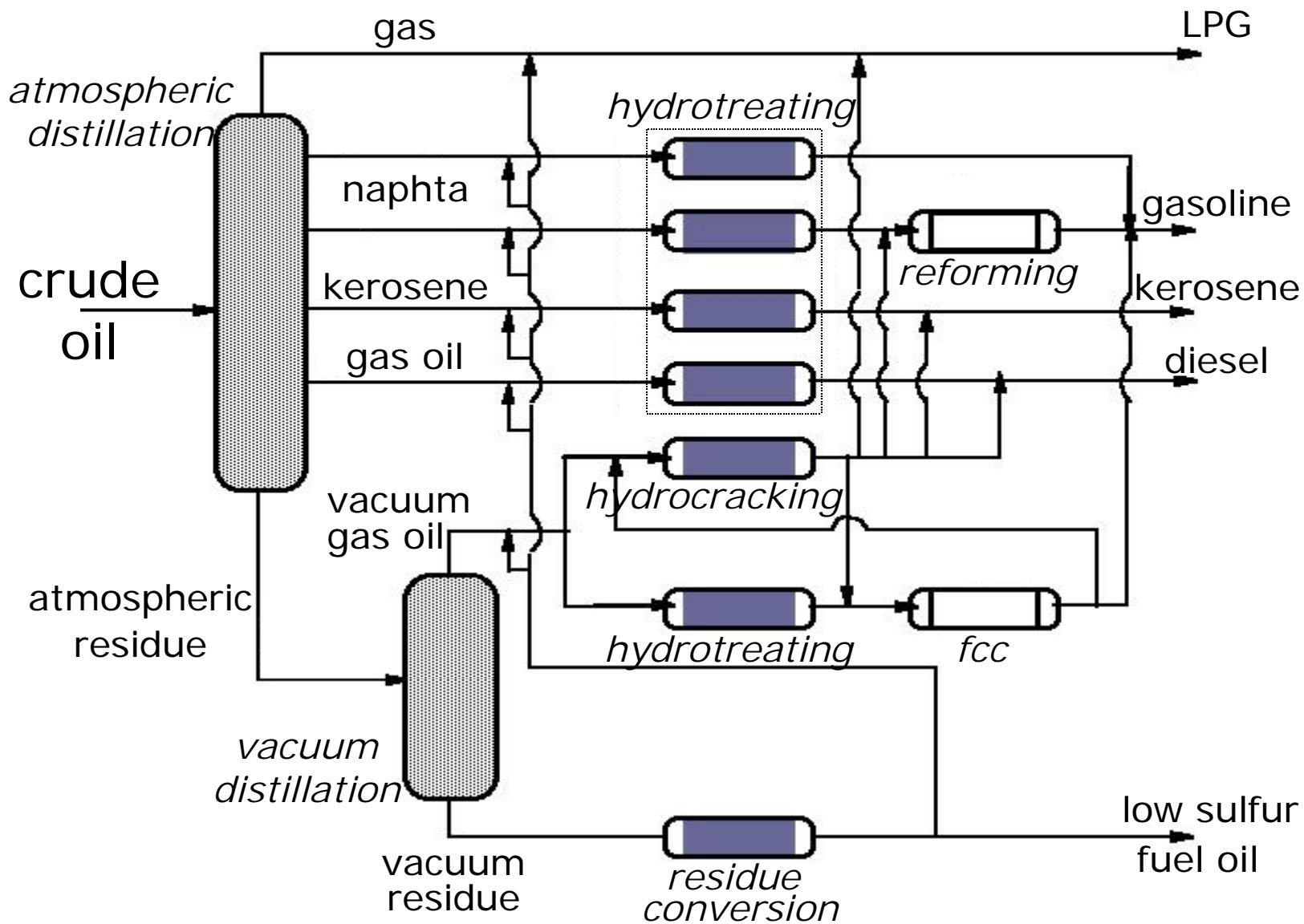
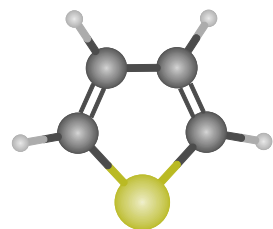
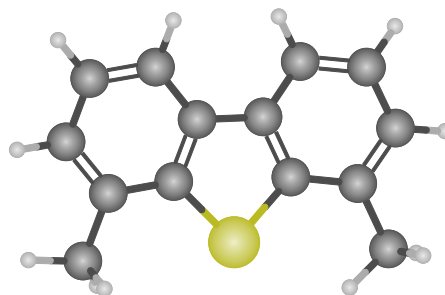


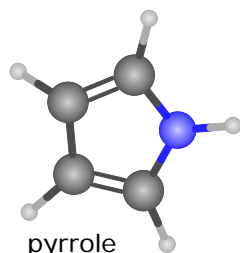
Figure 9.1



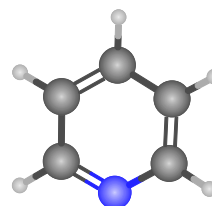
thiophene



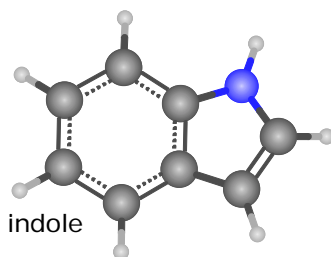
di-methyl di-benzo  
thiophene



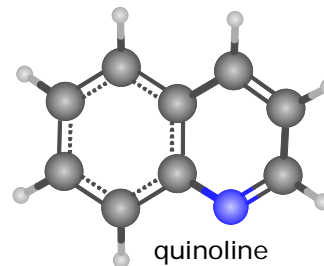
pyrrole



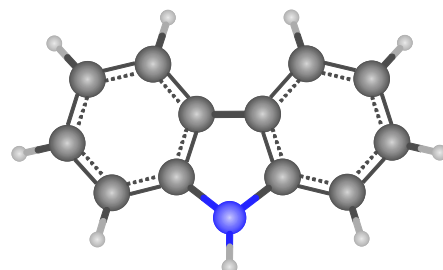
pyridine



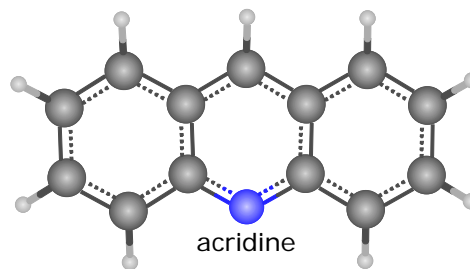
indole



quinoline



carbazole



acridine



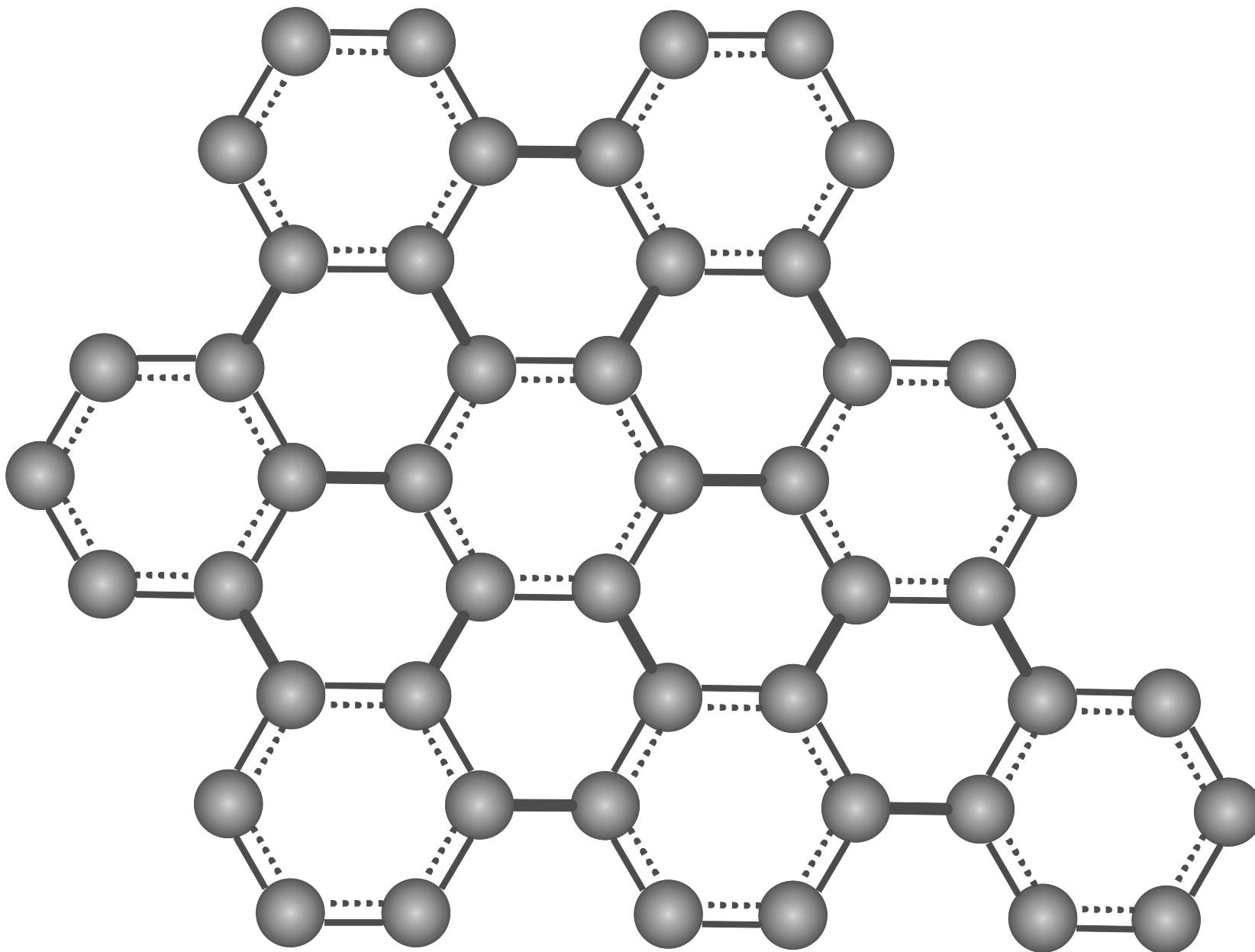
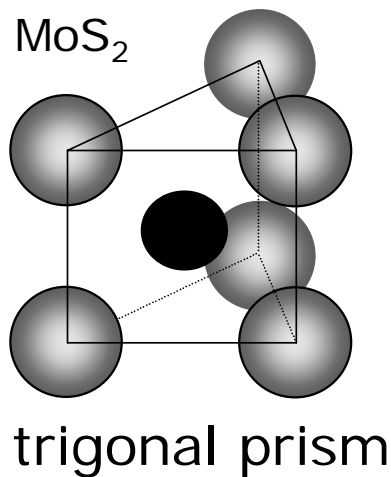


Figure 9.3







MoS<sub>2</sub>  
top view

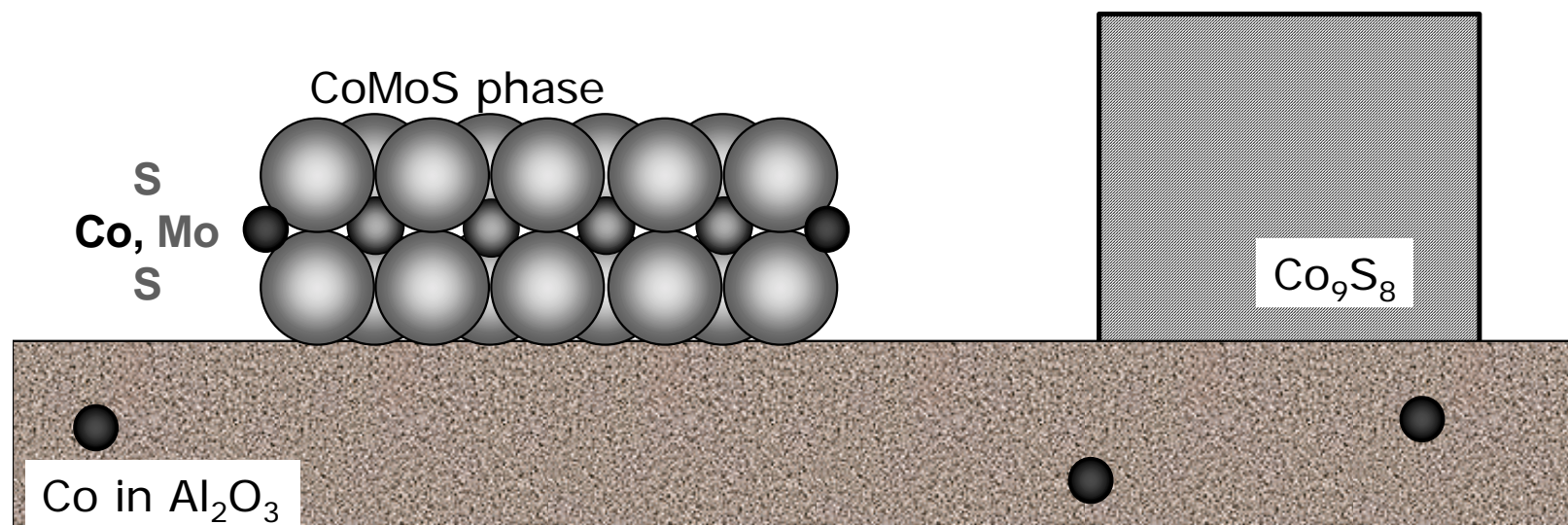
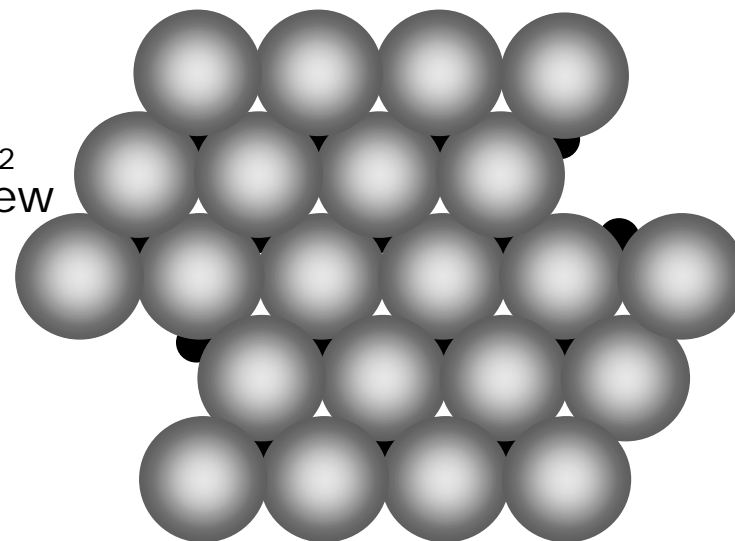


Figure 9.5

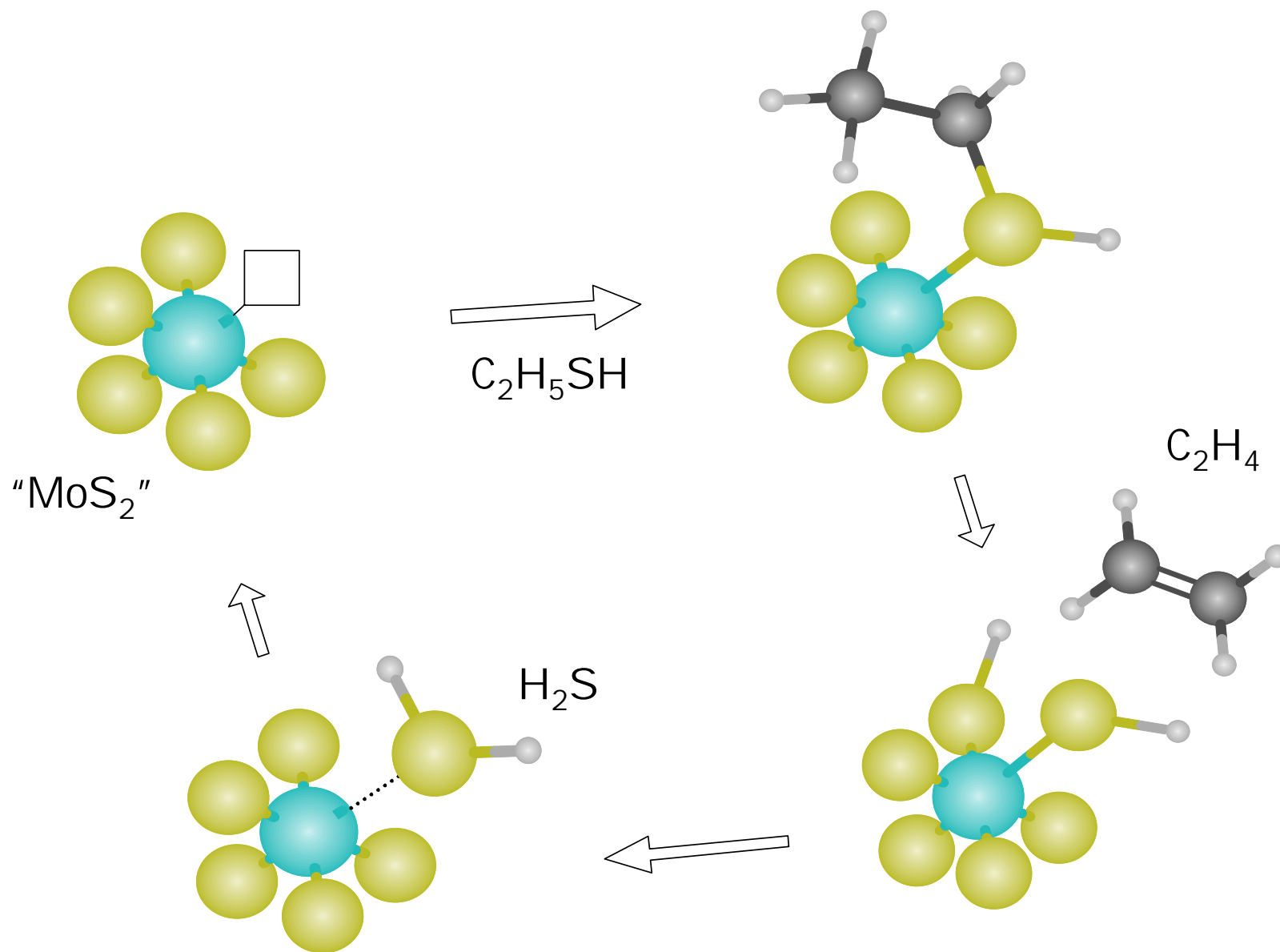


Figure 9.6

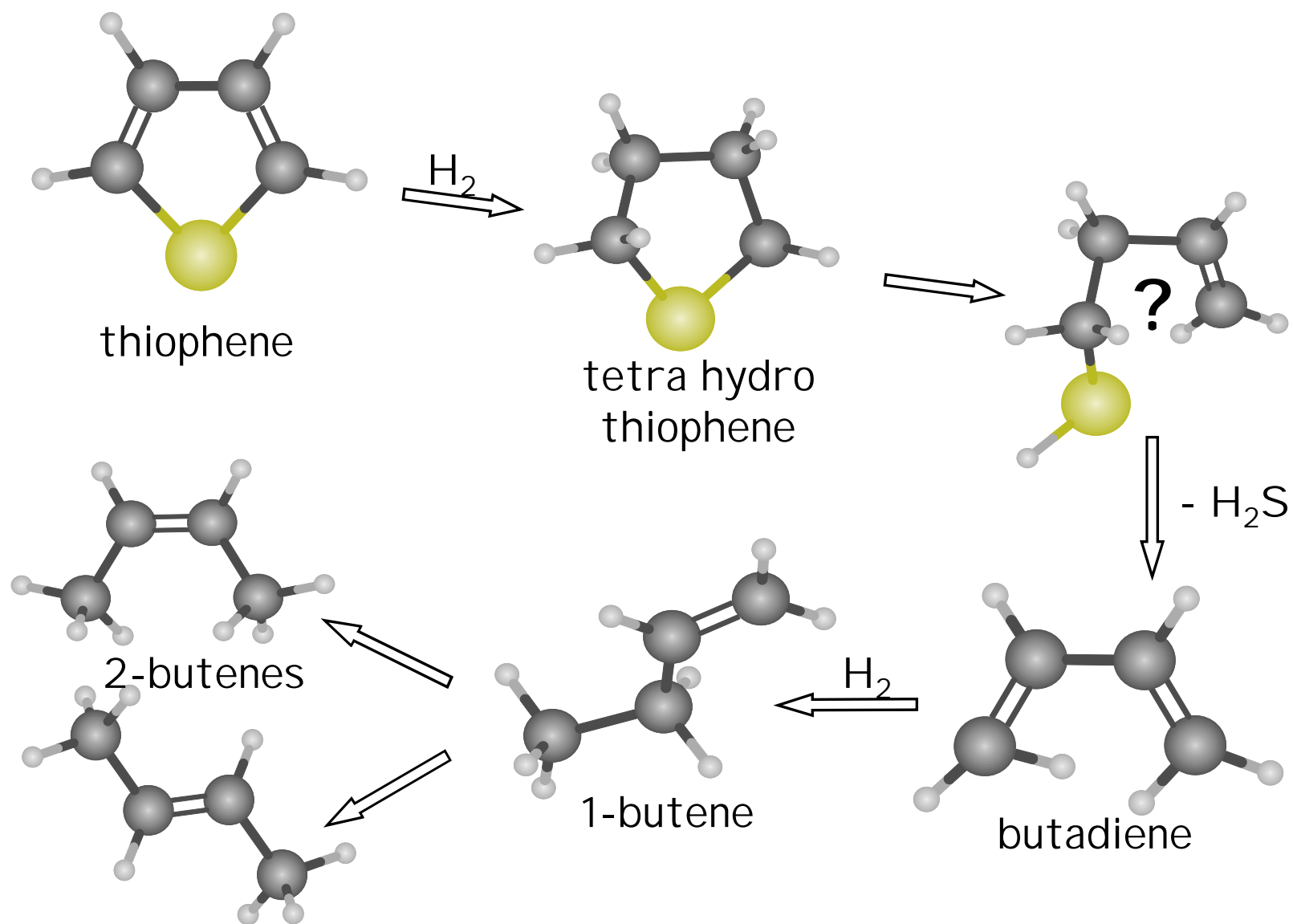


Figure 9.8

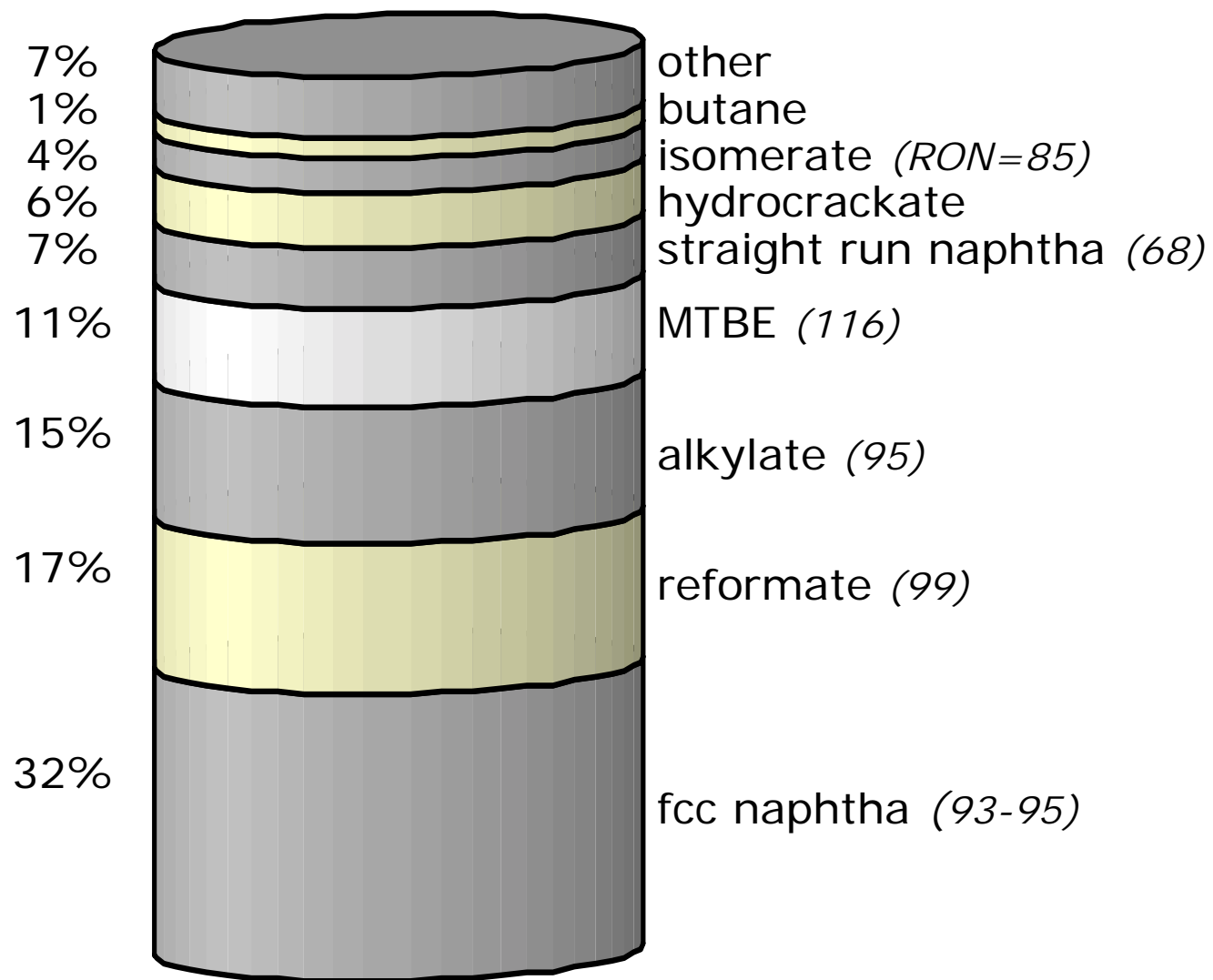


Figure 9.9

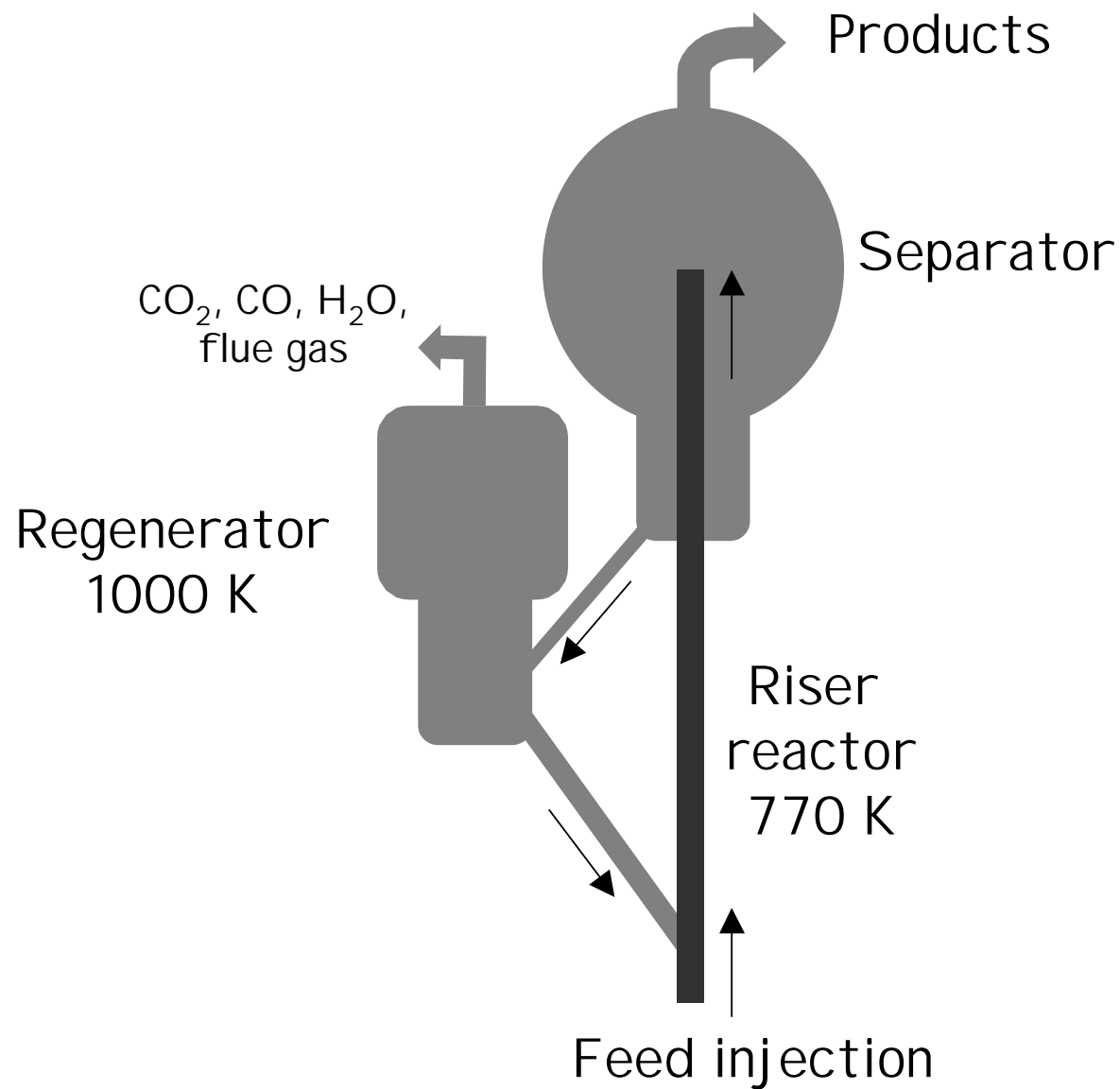


Figure 9.10



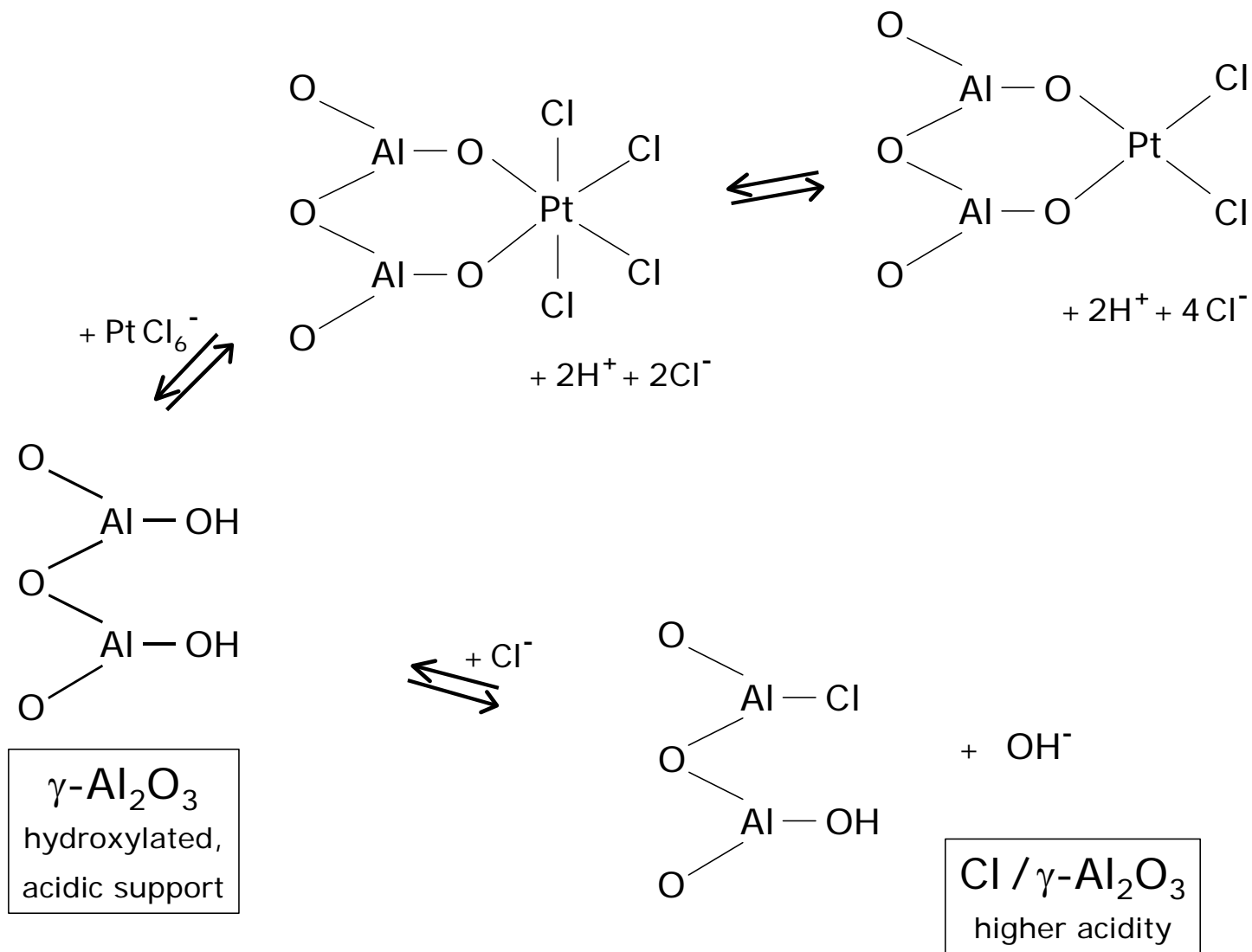


Figure 9.13

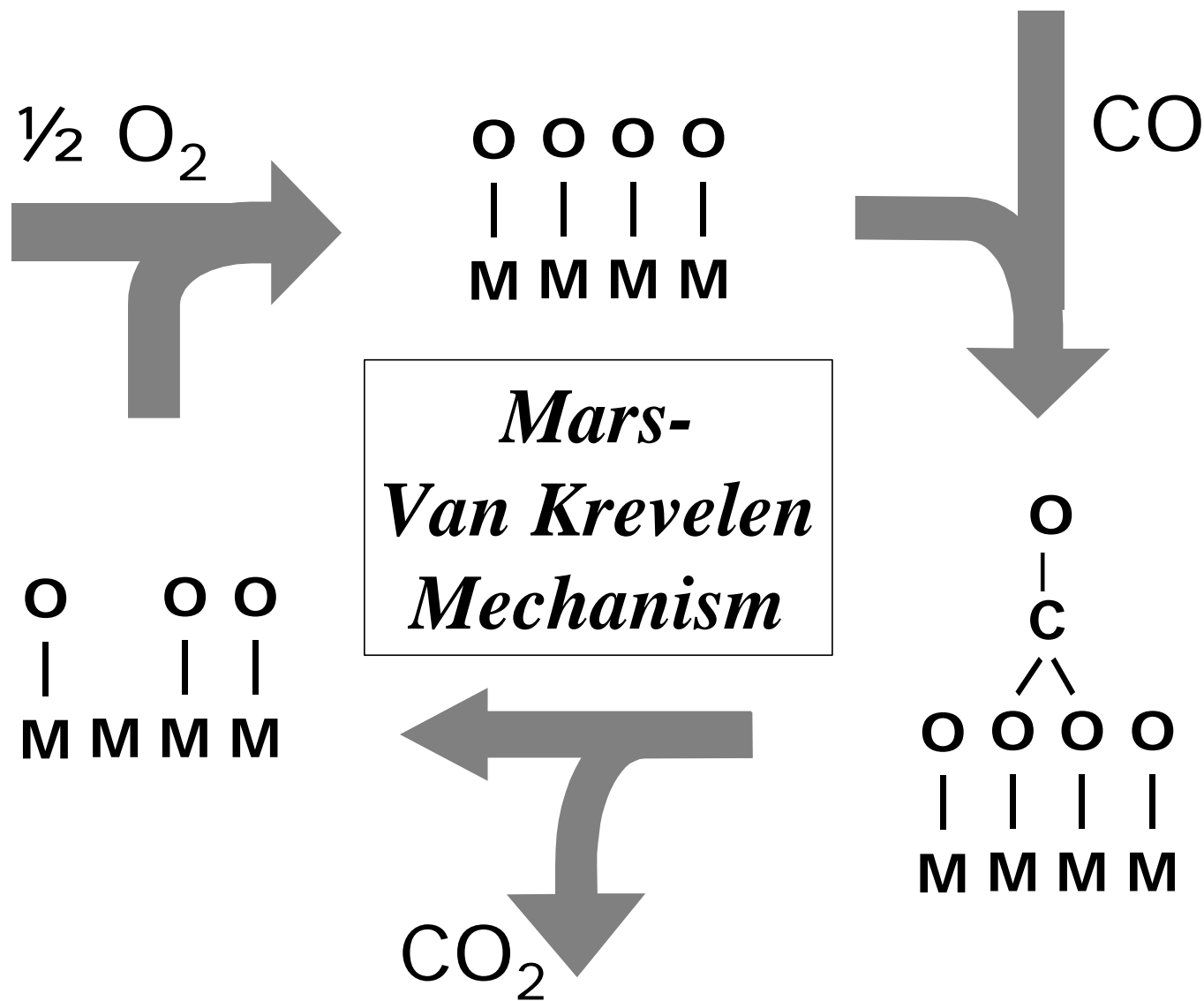


Figure 9.17



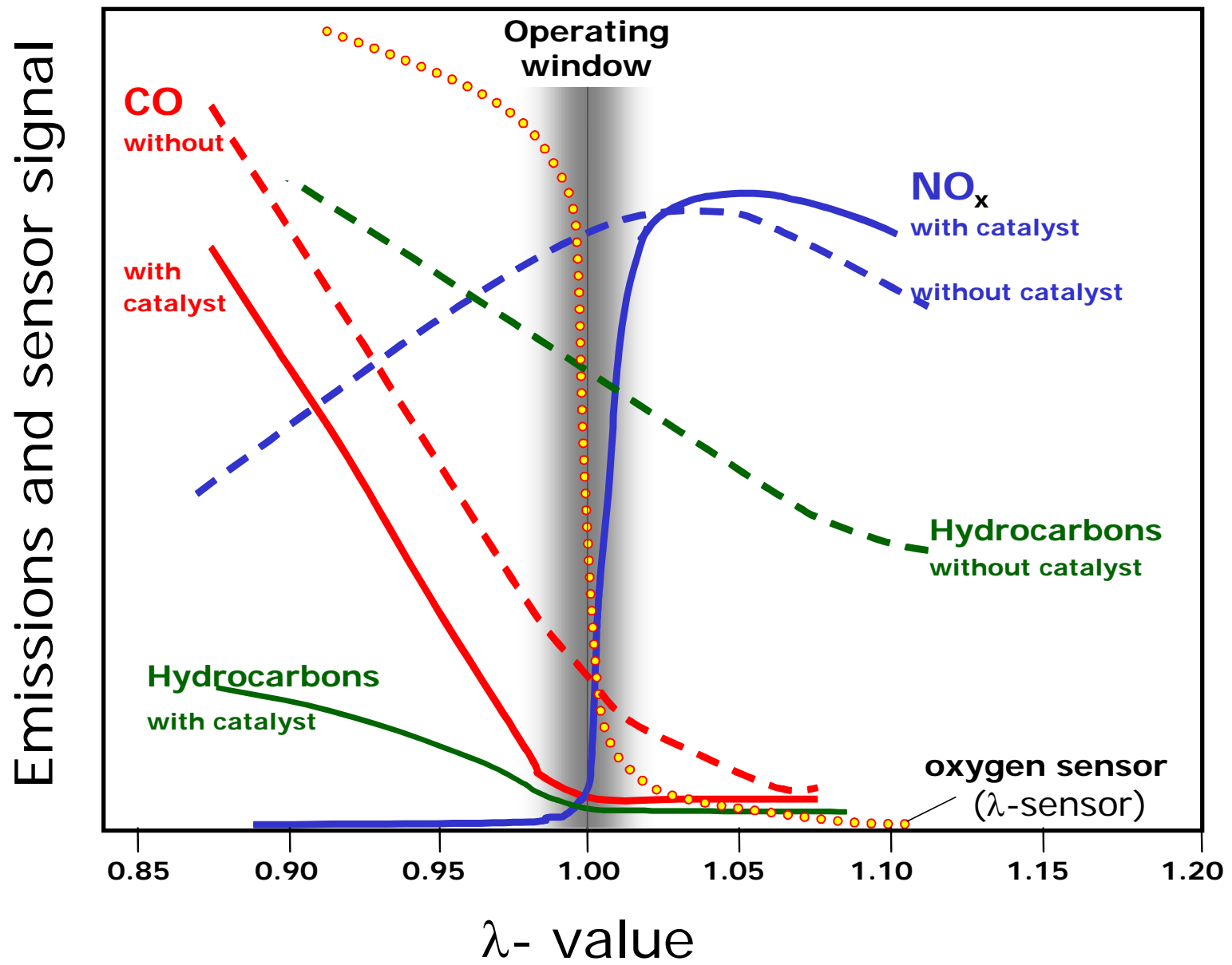


Figure 10.1

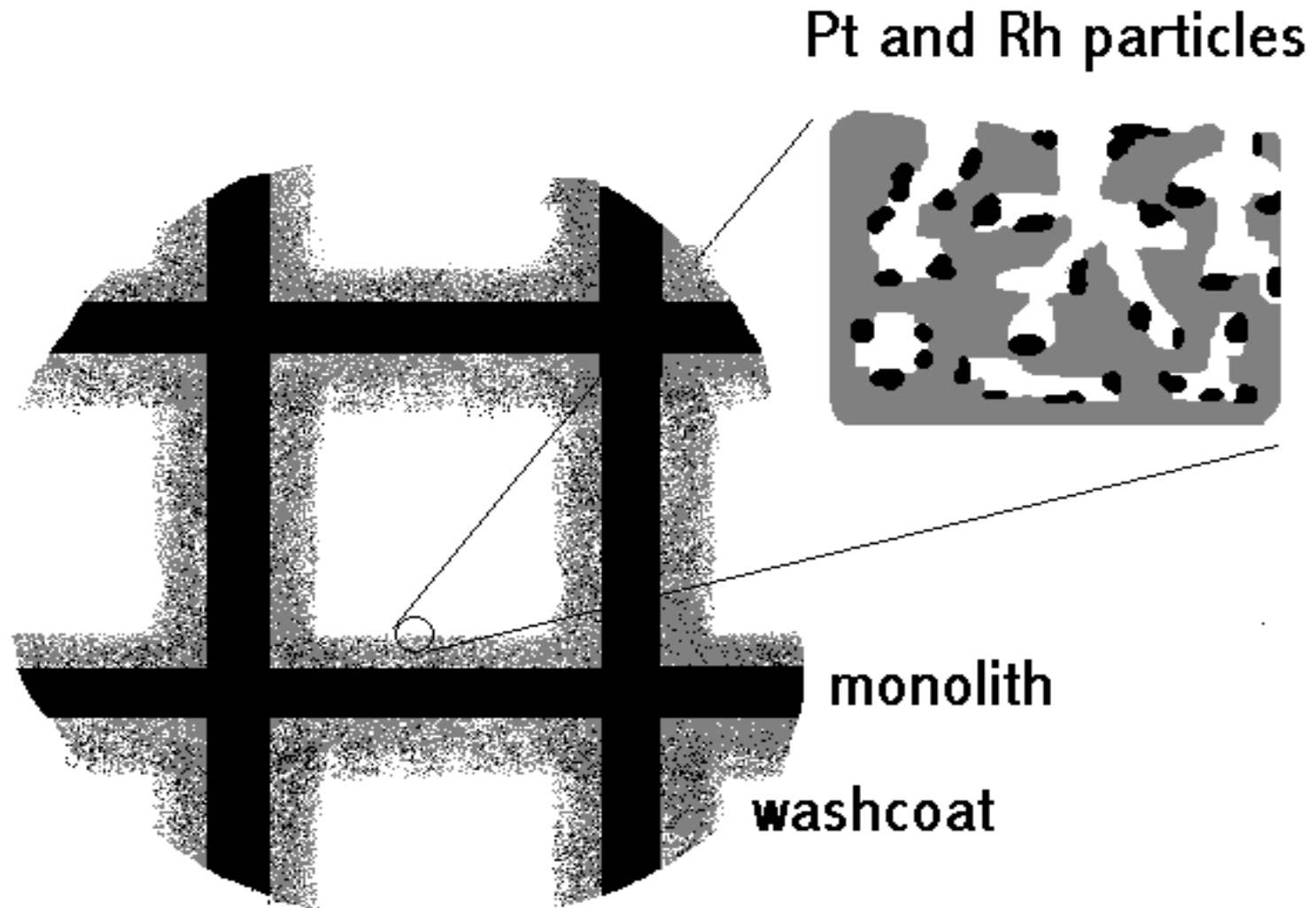


Figure 10.5

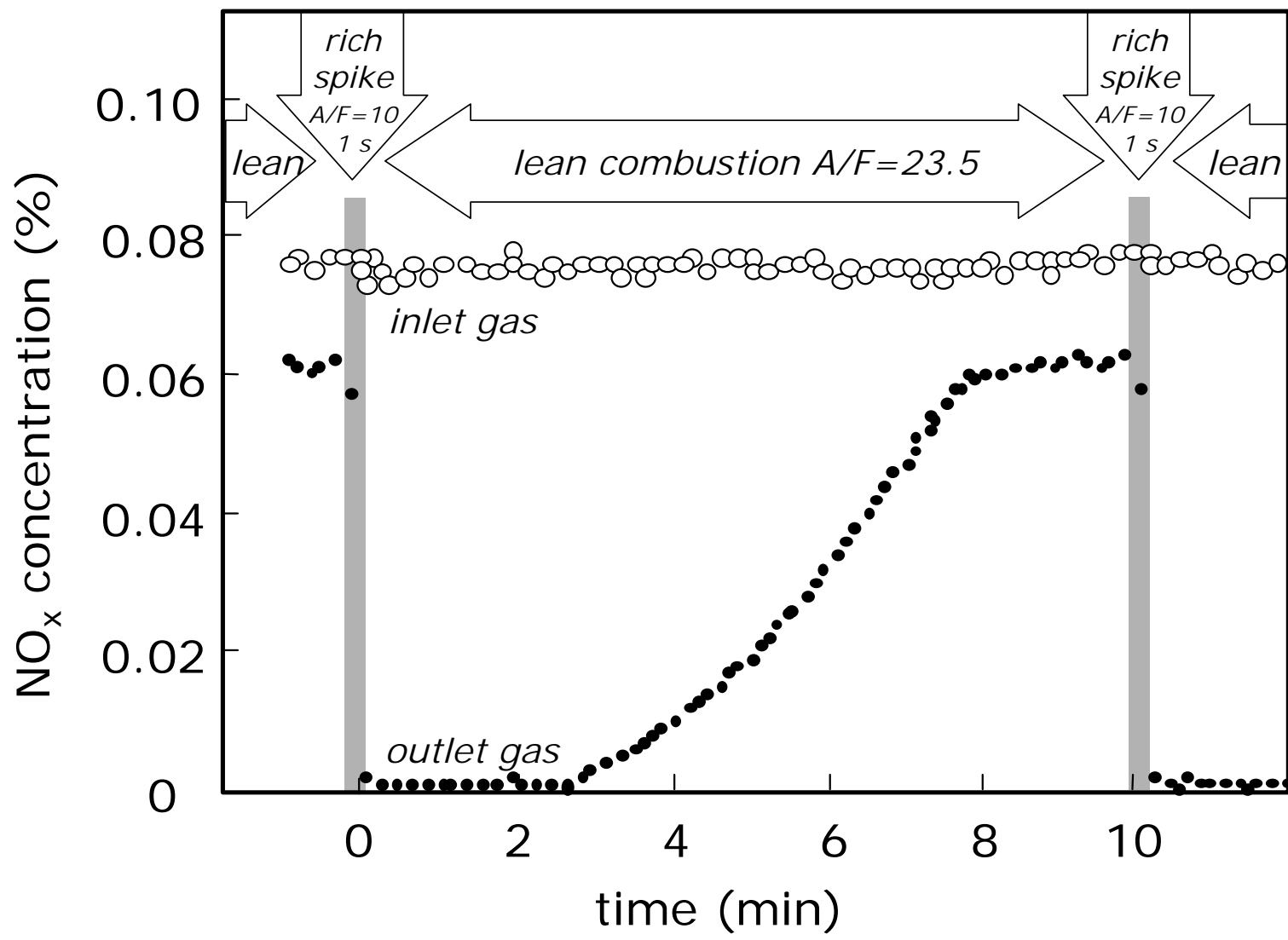


Figure 10.10